



VCU

Virginia Commonwealth University
VCU Scholars Compass

Theses and Dissertations

Graduate School

2014

Characterizing Cancellation Graphs

Cristina Mullican

Virginia Commonwealth University

Follow this and additional works at: <https://scholarscompass.vcu.edu/etd>



Part of the [Physical Sciences and Mathematics Commons](#)

© The Author

Downloaded from

<https://scholarscompass.vcu.edu/etd/3412>

This Thesis is brought to you for free and open access by the Graduate School at VCU Scholars Compass. It has been accepted for inclusion in Theses and Dissertations by an authorized administrator of VCU Scholars Compass. For more information, please contact libcompass@vcu.edu.

College of Humanities and Sciences
Virginia Commonwealth University

This is to certify that the thesis prepared by Cristina Elizabeth Mullican titled “Characterizing Cancellation Graphs” has been approved by his or her committee as satisfactory completion of the thesis requirement for the degree of Master of Science.

Richard Hammack, College of Humanities and Sciences

Ghidewon Abay-Asmerom, College of Humanities and Sciences

Yun Qu, College of Humanities and Sciences

Dewey Taylor, Director of Graduate Studies, Mathematics and Applied Mathematics

Coleman, Dean, College of Humanities and Sciences

Dr. F. Boudinot, Graduate Dean

Date

© Cristina Elizabeth Mullican 2014
All Rights Reserved

Characterizing Cancellation Graphs

A thesis submitted in partial fulfillment of the requirements for the degree of Master of Science at Virginia Commonwealth University.

by

Cristina Elizabeth Mullican
Master of Science

Director: Richard Hammack, Associate Professor
Department of Mathematics and Applied Mathematics

Virginia Commonwealth University
Richmond, Virginia
May 2014

Acknowledgment

Thank you Dr. Hammack for your guidance through the thesis process. You have taught me much about being a true mathematician from modeling how to ask good questions to how to clearly write mathematics. I have thoroughly enjoyed studying graph theory with you.

Thank you Gerhard for all of your support, encouragement, and love. I couldn't pursue my dreams without you!

Contents

Abstract	iv
1 <u>Preliminaries</u>	1
1.1 Introduction	1
1.2 Basic Definitions from Graph Theory	2
1.3 Mappings of Graphs	6
1.4 The Direct Product	8
2 <u>The Factorial and Anti-automorphisms</u>	14
2.1 Anti-automorphisms and Permuted Graphs	14
2.2 The Direct Product and Anti-Automorphisms	17
2.3 The Factorial	25
3 <u>Bipartite Cancellation Graphs</u>	33
3.1 Anti-Automorphisms and Bipartite Graphs	33
3.2 Characterizing Solutions of $G \times B \cong X \times B$ for bipartite G	41
4 <u>General Cancellation Graphs</u>	49
4.1 Standard Non-Bipartite Graphs	49
4.2 Non-Bipartite Cancellation Graphs	55
Bibliography	59
Vita	60

Abstract

CHARACTERIZING CANCELLATION GRAPHS

By Cristina Elizabeth Mullican, Master of Science.

A thesis submitted in partial fulfillment of the requirements for the degree of Master of Science at Virginia Commonwealth University.

Virginia Commonwealth University, 2014.

Director: Richard Hammack, Associate Professor, Department of Mathematics and Applied Mathematics.

A *cancellation graph* G is one for which given any graph C , we have $G \times C \cong X \times C$ implies $G \cong X$. In this thesis, we characterize all bipartite cancellation graphs. In addition, we characterize all solutions X to $G \times C \cong X \times C$ for bipartite G . A characterization of non-bipartite cancellation graphs is yet to be found. We present some examples of solutions X to $G \times C \cong X \times C$ for non-bipartite G , an example of a non-bipartite cancellation graph, and a conjecture regarding non-bipartite cancellation graphs.

Preliminaries

1.1 Introduction

This thesis discusses a characterization of cancellation graphs. That is, we seek to identify a simple property of a graph such that when this property holds for graph G , then $G \times C \cong X \times C$ implies that $G \cong X$ for all graphs C . We will present a characterization of bipartite cancellation graphs and discuss ideas relating to non-bipartite cancellation graphs.

Knowing how to identify all solutions X to the expression $G \times C \cong X \times C$ for any graph C is valuable in the search for cancellation graphs. We will look at a construction called the factorial of a graph G and show how this is used to characterize such solutions X . Involutions of graph G are central to the workings of these theories. We will show that involutions give us the characterization of bipartite cancellation graphs. Non-bipartite graphs pose a greater challenge but mysteriously, involutions seem to also be a keystone in characterizing non-bipartite cancellation graphs.

In the first chapter, we will review basic graph theory definitions and a few standard results. In the second chapter we will lay the foundation for our results by reviewing several of Lovász' results from the 1970's [3] as well as R. Hammack's key theorem from 2009 [5]. In the third chapter, we prove results pertaining to bipartite graphs and in the fourth chapter we will explore the non-bipartite case. We assume that all graphs are finite.

1.2 Basic Definitions from Graph Theory

We begin by reviewing definitions and concepts from Graph Theory beginning with a digraph.

DEFINITION 1.1. A *directed graph* or *digraph* $D = (V(D), E(D))$ is a relation $E(D) \subseteq V(D) \times V(D)$ on a set $V(D)$. The set $V(D)$ is the set of *vertices* of D and $E(D)$ is the set of the *directed edges*, or arcs of D . An ordered pair in $E(D)$ is denoted as $[u, v]$.

We can graphically represent a digraph by displaying the vertices as dots and each directed edge $[u, v]$ as an arrow pointing from u to v .

EXAMPLE 1.2. For digraph D pictured in Figure 1.1, the vertex set is $V(D) = \{v_1, v_2, v_3, v_4\}$ and the directed edge set is $E(D) = \{[v_1, v_1], [v_1, v_2], [v_2, v_1], [v_2, v_3], [v_2, v_4], [v_3, v_4]\}$. We call $[v_1, v_1]$ a loop. Notice that graphically, directed edge $[v_2, v_3]$ is depicted as an arrow from v_2 to v_3 . We say that the tail of the directed edge is at v_2 and that the head of the directed edge is at v_3 .

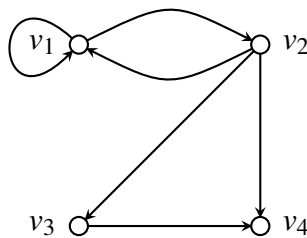

Figure 1.1: Digraph D , Example 1.2

DEFINITION 1.3. The *outdegree* of a vertex v_0 of a digraph D is the number of directed edges $[v_0, u]$ in $E(D)$.

Graphically, outdegree can be interpreted as the number of tails of directed edges leaving a vertex. For example, the outdegree of v_2 of digraph D in Figure 1.1 is three.

For the majority of discussion in this paper, we will be looking at a specific kind of digraph, the graph.

DEFINITION 1.4. A graph $G = (V(G), E(G))$ is a digraph such that $E(G)$ is a symmetric relation. In other words, $[u, v]$ is a directed edge of G if and only if $[v, u]$ is a directed edge of G . In graphs, we call $V(G)$ the *vertex set* and $E(G)$ the *edge set* of the graph.

Any graph can be visualized as points (the vertices), and edges that connect them. If $[v_1, v_2] \in E(G)$, we say that v_1 and v_2 are *adjacent* vertices. Given an edge $[v_1, v_2]$, we say that the edge is *incident* to vertices v_1 and v_2 . If two edges share a common vertex, we say the edges are *adjacent*.

EXAMPLE 1.5. Digraph G depicted in Figure 1.2 has a symmetric directed edge set and thus is also a graph. In Figure 1.2, both the digraph G and graph G are depicted. Because the edge set of graphs are symmetric, we can refer to any edge as $[v_1, v_2]$ or $[v_2, v_1]$. Note that there are no edges connecting v_4 to the other vertices. We say that v_4 is an *isolated vertex*. Also, there is no pair of vertices with multiple edges connecting them; this kind of structure is called a multigraph and will not be used in this paper. In a graph, every edge between a given pair of vertices is the unique such edge.

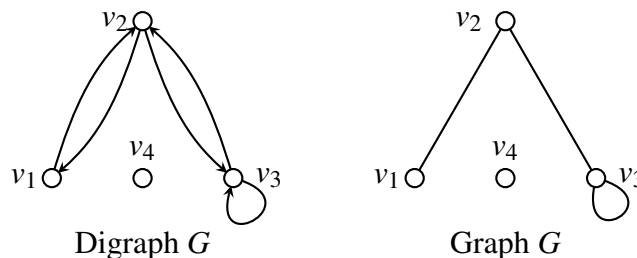

Figure 1.2: Example 1.5

Next, we discuss several features of graphs which will be useful to us.

DEFINITION 1.6. A graph H is a *subgraph* of graph G if $V(H) \subseteq V(G)$ and $E(H) \subseteq E(G)$.

For example, the graph H where $V(H) = \{v_2, v_3\}$ and $E(H) = \{[v_2, v_3]\}$ is a subgraph of graph G from Figure 1.2.

DEFINITION 1.7. The *degree* of a vertex v in a graph G is equal to the outdegree of v in the symmetric digraph of G . This is equivalent to the number of edges incident to v in graph G and is denoted by $\deg(v)$.

For example, in graph G from Figure 1.2, vertex v_2 has degree 2 because both edges $[v_2, v_1]$ and $[v_2, v_3]$ belong to G . So we write $\deg(v_2) = 2$. Also, $\deg(v_4) = 0$ because v_4 is an isolated vertex. Furthermore, notice that the outdegree of v_3 in digraph G is two. Thus $\deg v_3 = 2$ in graph G as well. In general, a loop contributes a value of one to the degree of an incident vertex.

DEFINITION 1.8. A u - v *walk* in a graph G is a finite sequence of vertices starting with u and ending with v such that each consecutive pair of vertices is adjacent in the graph.

A u - v *path* in a graph G is a finite sequence of vertices $u, w_1, w_2, \dots, w_n, v$ starting with u and ending with v such that each consecutive pair of vertices is adjacent in the graph and no vertex repeats in w_1, w_2, \dots, w_n .

The *length* of a path or walk is the number of edges encountered in the path or walk.

A *cycle* in a graph is a v - v path. A path is either a loop or has length greater than two.

A graph G is *connected* if for every pair u, v of vertices in G , the graph G contains a u - v path.

A subgraph H is a *component* of graph G if H is a maximal connected subgraph of G .

EXAMPLE 1.9. Consider graph G depicted in Figure 1.3. The bold edges show a v_2 - v_6 walk. Notice that G is not a connected graph. For instance, there is no v_5 - v_8 path in G . However, subgraph H is a maximal connected subgraph of G and is thus a component of G .

In addition to properties of graphs, we will review some standard classes of graphs.

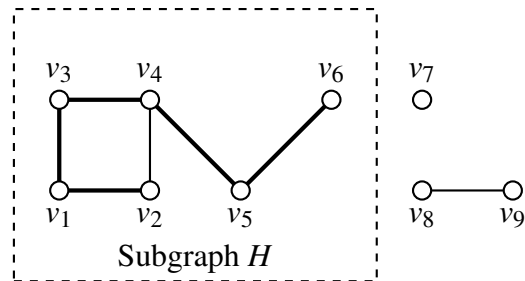
Figure 1.3: Graph G

DEFINITION 1.10. A *complete graph* K_n is a graph with n vertices such that any vertex is adjacent to all other vertices.

A *cycle* is a graph C_n with n vertices such that $V(C_n) = \{v_1, v_2, \dots, v_n\}$ and $E(C_n) = \{[v_1, v_2], [v_2, v_3], \dots, [v_{n-1}, v_n], [v_n, v_1]\}$.

Refer to Figure 1.4 for some examples of cycles and complete graphs.

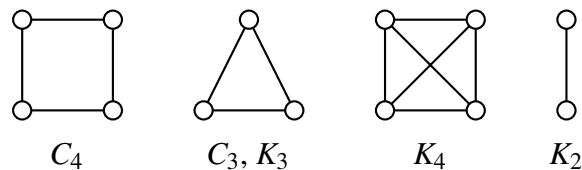
Figure 1.4: Examples of C_n and K_n

Chapter 3 is based around the following class of graphs.

DEFINITION 1.11. A graph G is *bipartite* if the vertices of G can be partitioned into two *partite sets* X and Y such that each edge of G has one endpoint in X and the other endpoint in Y .

EXAMPLE 1.12. The graph from Figure 1.3 is bipartite. Let $X = \{v_1, v_4, v_6, v_7, v_9\}$ and $Y = \{v_2, v_3, v_5, v_8\}$. Figure 1.5 graphically represents this partition by depicting the vertices in X with white circles and the vertices of Y with gray circles. All edges run between the white and gray vertices.

A *proper coloring* of a graph H is a function that assigns a color to each vertex of the graph such that every pair of adjacent vertices are colored with different colors. The *chromatic number* of a graph, $\chi(H)$ is the smallest number of colors required in a proper coloring of the graph H . Notice that a graph H is bipartite if and only if $\chi(H) = 2$.

Our coloring of the vertices of the bipartite Graph G represented in Figure 1.5 is a proper coloring. Because two colors are the least number required for a proper coloring, $\chi(G) = 2$.

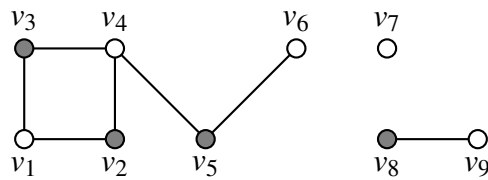

Figure 1.5: Bipartite Graph G , Example 1.12

The following standard graph theory result gives a helpful characterization for bipartite graphs. A proof can be found on page 37 of Chartrand's, Lesniak's and Zhang's *Graphs & Digraphs* [1].

PROPOSITION 1.13. A graph G is bipartite if and only if it does not contain a cycle of odd length.

1.3 Mappings of Graphs

We now move on to define mappings from one graph to another. Functions from graph A to graph B will map vertices of A to vertices of B . Because graphs are comprised of both vertices and edges, we would like our mappings to relate the edges of A to the edges of B .

DEFINITION 1.14. A *homomorphism* σ from graph A to graph B is a map $\sigma : V(A) \rightarrow V(B)$ for which $[x, y] \in E(A)$ implies that $[\sigma(x), \sigma(y)] \in E(B)$.

EXAMPLE 1.15. Consider graphs G and U in Figure 1.6. Let σ be the function defined by $\sigma(v_1) = \sigma(v_4) = u_1$ and $\sigma(v_2) = \sigma(v_3) = u_2$. The reader can check that σ is a homomorphism from G to U .

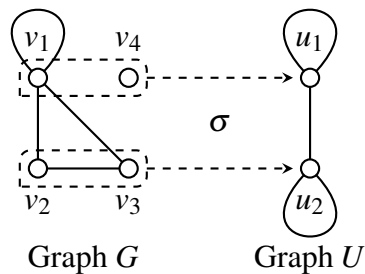

Figure 1.6: Homomorphism σ

We can further strengthen the notion of homomorphism to find a mapping from one graph to another that tells us the graphs are essentially the same.

DEFINITION 1.16. An *isomorphism* γ from graph A to graph B is a bijection $\gamma: V(A) \rightarrow V(B)$ for which $[x, y] \in E(A)$ if and only if $[\gamma(x), \gamma(y)] \in E(B)$. When there is an isomorphism from A to B we say A and B are *isomorphic* and denote this as $A \cong B$.

The graphic representations of two isomorphic graphs can look very different from one another; however, redrawing one graph with modified vertex placement can reveal to the viewer that they are in essence the same graph.

Recall that a permutation is a bijective function from a set onto itself. Similarly, we can define mappings from a graph to itself.

DEFINITION 1.17. Let G be a graph. A function $\alpha: V(G) \rightarrow V(G)$ is an *automorphism* if α is an isomorphism.

EXAMPLE 1.18. In order to find an automorphism of G , we can start with the set of permutations on $V(G)$ and then check to see which permutations are isomorphisms. Recall cycle notation, a convenient way to represent permutations. Consider K_3 with vertices 1,

2, and 3. Then the permutation $(1\ 3\ 2)$ is the permutation that maps vertex 1 to vertex 3, maps vertex 3 to vertex 2, and maps vertex 2 to vertex 1. Notice that $(1\ 3\ 2)$ is indeed the automorphism equivalent to rotating K_3 by 120° counterclockwise.

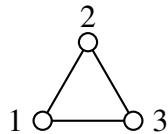

Figure 1.7: K_3

1.4 The Direct Product

We are now ready to define the direct product, a definition paramount to the remaining discussions in this thesis.

DEFINITION 1.19. The direct product of graphs A and B is a graph $A \times B$ with vertex set $V(A) \times V(B)$. Edge $[(a_1, b_1), (a_2, b_2)]$ belongs to $A \times B$ if and only if $[a_1, a_2] \in E(A)$ and $[b_1, b_2] \in E(B)$.

EXAMPLE 1.20. Figure 1.8 shows two examples of direct products. Notice that in the second example, graph G is bipartite. When we “untangle” $K_2 \times G$, we see that this is isomorphic to two copies of graph G .

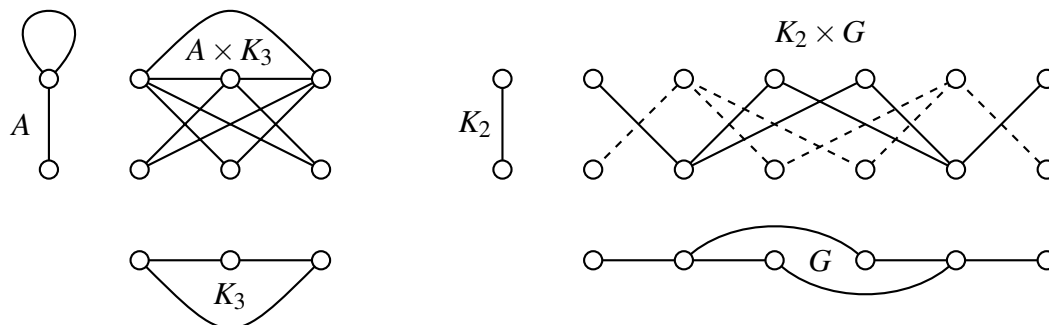

Figure 1.8: Graphs $A \times K_3$ and $K_2 \times G$

The direct product has some interesting properties. We are interested in the connectedness of a direct product. First, we define a projection.

DEFINITION 1.21. The *projections* of direct product $G \times H$ are

- $\text{proj}_G : V(G \times H) \rightarrow V(G)$ where $\text{proj}_G(g, h) = g$ and
- $\text{proj}_H : V(G \times H) \rightarrow V(H)$ where $\text{proj}_H(g, h) = h$.

It is easy to check that both of these are homomorphisms.

PROPOSITION 1.22. Suppose (g, h) and (g', h') are vertices in the direct product $G \times H$. If there is a g - g' walk of length n in G and an h - h' walk of length n in H , then there is a (g, h) - (g', h') walk of length n in $G \times H$. If for every $n \in \mathbb{N}$, there is no g - g' walk of length n in G and no h - h' walk of length n in H then there is no (g, h) - (g', h') path in $G \times H$.

Proof. We begin by proving the first statement. Suppose there is a g - g' walk of length n in G given by $g, a_1, \dots, a_{n-1}, g'$ and an h - h' walk of length n in H given by $h, b_1, \dots, b_{n-1}, h'$. Then by definition of direct product, $(g, h), (a_1, b_1), \dots, (a_{n-1}, b_{n-1}), (g', h')$ is a walk in $G \times H$ and it is also of length n . Given a walk between two vertices, there always exists a path between the two vertices which is obtained by deleting any repeating sequences of vertices in the walk.

We will prove the second statement by the contrapositive. Suppose $G \times H$ contains a (g, h) - (g', h') walk of length n in $G \times H$, which is $(g, h), (a_1, b_1), \dots, (a_{n-1}, b_{n-1}), (g', h')$. By proj_G , there is a walk $g, a_1, \dots, a_{n-1}, g'$ of length n in G . By proj_H , there is a walk $h, b_1, \dots, b_{n-1}, h'$ of length n in H . □

Suppose that a u - v walk and an x - y walk both have the same parity. It follows that one walk can be extended to match the length of the other. Suppose that the length of the u - v walk is shorter than the x - y walk. Because they have the same parity, then their lengths

differ by an even number. Call the vertex adjacent to v vertex w . Then add on w, v, w, v, \dots, w, v to walk $u-v$ as many times as needed until the lengths of the walks match.

Let's consider the direct product $G \times H$ when both G and H are bipartite. The following theorem is due to Weichsel [2].

PROPOSITION 1.23. Suppose that G and H are both connected bipartite graphs. Then $G \times H$ contains exactly two components.

Proof. Suppose G and H are two bipartite graphs with partite sets G_0, G_1 , and H_0, H_1 respectively. Let $g, g' \in G_0$ and $h \in H_0, h' \in H_1$. Because g and g' are in the same partite set, then every $g-g'$ walk must have even length. Because h and h' are in different partite sets, any $h-h'$ walk must have odd length. So by Proposition 1.22, there is no $(g, h)-(g', h')$ path in $G \times H$ and thus $G \times H$ is not connected. Thus it has at least two components.

Now we will show that $G \times H$ has exactly two components. Let (g, h) be a vertex of $G \times H$ and suppose vertices (g', h') and (g'', h'') are not in the same component as (g, h) . Therefore, a $g-g'$ walk in G has length of opposite parity of an $h-h'$ walk in H . Likewise a $g-g''$ walk in G has length of opposite parity of an $h-h''$ walk in H .

Case 1: Suppose that the parity of the lengths of the $g-g'$ walk and the $g-g''$ walk matches. Then the parity of the lengths of the $h-h'$ walk and the $h-h''$ walk in H matches. Then the $g'-g''$ walk formed by putting the $g-g'$ walk and the $g-g''$ walk together is even. Likewise, the $h'-h''$ walk is even in H . Thus by the comment above, there exists a $g'-g''$ walk and an $h'-h''$ walk that have equal length. So by Proposition 1.22, (g', h') and (g'', h'') are connected by a path in $G \times H$ and are thus in the same component.

Case 2: Suppose that the parity of the length of the $g-g'$ walk is opposite of the $g-g''$ walk. It follows that the lengths of the $h-h'$ walk and the $h-h''$ walk in H have opposite parity as well. Thus, the $g'-g''$ walk formed by putting the $g-g'$ walk and the $g-g''$ walk together has odd length as does the $h'-h''$ walk. Thus by the comment above, there exists a $g'-g''$ walk

and an $h'-h''$ walk that have equal length. So by Proposition 1.22, (g', h') and (g'', h'') are connected by a path in $G \times H$ and are thus in the same component. \square

The following proposition will be useful to us in chapter 3.

PROPOSITION 1.24. Let G be a bipartite graph. Then $G \times K_2 = 2G$.

Proof. Let G be a bipartite graph with partite sets X and Y . The partite sets of K_2 are $\{0\}$ and $\{1\}$. Let $\varepsilon \in \{0, 1\}$. By definition of direct product, every edge of $G \times K_2$ must be in the form $[(x, \varepsilon), (y, \varepsilon + 1 \pmod{2})]$ or $[(y, \varepsilon), (x, \varepsilon + 1 \pmod{2})]$ for $x \in X$ and $y \in Y$. Hence, edges are incident to vertices in $X \times \{1\}$ and $Y \times \{0\}$ or the edges are incident to vertices in the sets $X \times \{0\}$ and $Y \times \{1\}$.

It follows that $G \times K_2 = G_1 + G_2$ where $V(G_1) = (X \times \{0\}) \cup (Y \times \{1\})$ and $E(G_1) = \{[(x, 0), (y, 1)] : x \in X, y \in Y \text{ and } [x, y] \in E(G)\}$ in addition to $V(G_2) = (X \times \{1\}) \cup (Y \times \{0\})$ and $E(G_2) = \{[(x, 1), (y, 0)] : x \in X, y \in Y \text{ and } [x, y] \in E(G)\}$.

Proving that $G_1 \cong G_2 \cong G$ will prove the proposition. First, we will show that $G_1 \cong G_2$.

Let $\gamma: G_1 \rightarrow G_2$ be the function defined by $\gamma((g, \varepsilon)) = (g, \varepsilon + 1 \pmod{2})$. We will show that γ is an isomorphism from G_1 to G_2 . First, note that the function γ is a homomorphism:

$$\begin{aligned} [(x, 0), (y, 1)] \in E(G_1) &\Leftrightarrow x \in X, y \in Y \text{ and } [x, y] \in E(G) \\ &\Leftrightarrow [(x, 1), (y, 0)] \in E(G_2) \\ &\Leftrightarrow [\gamma((x, 0)), \gamma((y, 1))] \in E(G_2). \end{aligned}$$

Because $[(x, 0), (y, 1)] \in E(G_1)$ if and only if $[\gamma((x, 0)), \gamma((y, 1))] \in E(G_2)$, then γ is an isomorphism if γ is a bijection.

We must show that γ is a bijection from $V(G_1)$ to $V(G_2)$ in order to show that γ is an isomorphism. Suppose that $\gamma(g, i) = \gamma(h, j)$. Then, $(g, i + 1 \pmod{2}) = (h, j + 1 \pmod{2})$. Because i and j can only be 0 or 1, it follows that $i = j$ and $g = h$ and so $(g, i) = (h, j)$.

Therefore, γ is injective. Suppose that $(g, i) \in V(G_2)$. Either $g \in X$ and $i = 1$, or $g \in Y$ and $i = 0$. If the former is true, then $(g, 0) \in V(G_1)$ and $\gamma(g, 0) = (g, 1)$. If the latter is true, then $(g, 1) \in V(G_1)$ and $\gamma(g, 1) = (g, 0)$. Therefore, γ is surjective.

It follows that γ is an isomorphism and so $G_1 \cong G_2$. Now we must show that $G_1 \cong G$.

Let $\Phi : G \rightarrow G_1$ be defined as

$$\Phi(g) = \begin{cases} (g, 0) & \text{if } g \in X \\ (g, 1) & \text{if } g \in Y. \end{cases}$$

We will show that Φ is an isomorphism. Recall that G is bipartite with partite sets X and Y . Then for $x \in X$ and $y \in Y$,

$$\begin{aligned} [x, y] \in E(G) &\Leftrightarrow [(x, 0), (y, 1)] \in E(G_1) && \text{by definition of } G_1 \\ &\Leftrightarrow [\Phi(x), \Phi(y)] \in E(G_1). \end{aligned}$$

Because $[x, y] \in E(G)$ if and only if $[\Phi(x), \Phi(y)] \in E(G_1)$, then Φ is an isomorphism if Φ is bijective. Now we proceed by showing that Φ is a bijection.

Suppose that $\Phi(g) = \Phi(h)$. Then $(g, i) = (h, j)$ which implies that $g = h$. Hence, Φ is injective. To show surjectivity, let $(g, i) \in G_1$. Either $g \in X$ and $i = 0$ or $g \in Y$ and $i = 1$. If the former is true, then $\Phi(g) = (g, 0)$. If the latter is true, then $\Phi(g) = (g, 1)$.

Therefore, Φ is bijective. Thus Φ is an isomorphism and therefore, $G \cong G_1$. It follows that $G \cong G_1 \cong G_2$ and therefore, $G \times K_2 = G_1 + G_2 = 2G$. \square

These structural properties of the direct product will aid us in looking for solutions X in the expression $G \times C \cong X \times C$ which will ultimately help us characterize cancellation graphs. In order to give us direction, we look to László Lovász' following two propositions, the first of which is a consequence to the second [3]. To date, no graph-theoretic proof to these theorems is known.

PROPOSITION 1.25. If $A \times C \cong B \times C$, and C has an odd cycle, then $A \cong B$.

PROPOSITION 1.26. If A, B , and C are graphs and $A \times C \cong B \times C$, then there is an isomorphism $A \times C \rightarrow B \times C$ with $(a, c) \mapsto (\phi(a, c), c)$.

Recall Proposition 1.13 which stated that a graph is non-bipartite if and only if it contains an odd cycle. Therefore, we know all solutions for graph X to $G \times C \cong X \times C$ when C is non-bipartite: the only solution is graph G . Therefore, the only interesting case is finding solutions X for $G \times B \cong X \times B$ when B is bipartite. Understanding how to identify all solutions X will aid us in characterizing the following special class of graphs.

DEFINITION 1.27. A graph G is a *cancellation graph* if $G \times C \cong X \times C$ implies $G \cong X$ for all graphs C . In other words, the only solution to $G \times C \cong X \times C$ is graph G .

We will give a characterization of all bipartite cancellation graphs in Chapter 3 and will give some partial results for the non-bipartite case in Chapter 4.

The Factorial and Anti-automorphisms

As we pursue solutions of $G \times B \cong X \times B$, we need to review several results to establish relationships between G and solutions X .

2.1 Anti-automorphisms and Permuted Graphs

DEFINITION 2.1. An *anti-automorphism* of a graph G is a bijection $\alpha : V(G) \rightarrow V(G)$ such that $[x,y] \in E(G)$ if and only if $[\alpha(x), \alpha^{-1}(y)] \in E(G)$. We denote the set of all anti-automorphisms of graph G as $\text{Ant}(G)$.

DEFINITION 2.2. An *involution* of a graph G is an automorphism μ such that μ has order two. Note that involutions are also anti-automorphisms of G because $\mu^{-1} = \mu$.

EXAMPLE 2.3. In the graph G in Figure 2.1, the permutation α , rotation by 90° is an anti-automorphism. For example, $[4,3] \in E(G)$ and $[\alpha(4), \alpha^{-1}(3)] = [1,2] \in E(G)$. The reader can check that $[\alpha(x), \alpha^{-1}(y)] \in E(G)$ if and only if $[x,y] \in E(G)$ for all edges in G .

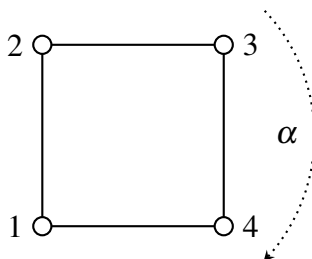

Figure 2.1: Example 2.3, Graph G

DEFINITION 2.4. Given a digraph D and a bijection $\gamma : V(D) \rightarrow V(D)$, we define the *permuted digraph* D^γ as follows. Its vertices are $V(D^\gamma) = V(D)$ and its edges are $E(D^\gamma) = \{[x, \gamma(y)] : [x, y] \in E(D)\}$.

Note that $[x, y] \in E(D)$ if and only $[x, \gamma(y)] \in E(D^\gamma)$ and $[a, b] \in E(D^\gamma)$ if and only if $[a, \gamma^{-1}(b)] \in E(D)$.

When we find the permuted digraph of a graph G , it is helpful to think of G as a symmetric digraph because we must look at each directed edge individually. In general, $[x, y]$ which is mapped to $[x, \gamma(y)]$ in D^γ is not the same as $[y, x]$ which is mapped to $[y, \gamma(x)]$ in D^γ , the permuted digraph. Also, notice that even if G is a graph, G^γ is not necessarily a graph. If $[x, \gamma(y)]$ is a directed edge of the permuted digraph G^γ , it is not necessarily the case that $[\gamma(y), x]$ is a directed edge of G^γ .

EXAMPLE 2.5. Consider graph G from Figure 2.2 permuted by the permutation $\sigma = (1\ 3)$. When we permute graphs, we must consider each arc individually. To find G^σ , we carry out the following calculations:

G	G^σ
[1, 2]	[1, $\sigma(2)$] = [1, 2]
[2, 1]	[2, $\sigma(1)$] = [2, 3]
[2, 3]	[2, $\sigma(3)$] = [2, 1]
[3, 2]	[3, $\sigma(2)$] = [3, 2]
[3, 3]	[3, $\sigma(3)$] = [3, 1]

Note that G^σ is not a graph because G^σ contains $[3, 1]$ but not $[1, 3]$.

Hammack's result [4] crystallizes why we are interested in anti-automorphisms:

PROPOSITION 2.6. Suppose π is a permutation of the vertices of graph G . Then G^π is a graph if and only if $\pi \in \text{Ant}(G)$.

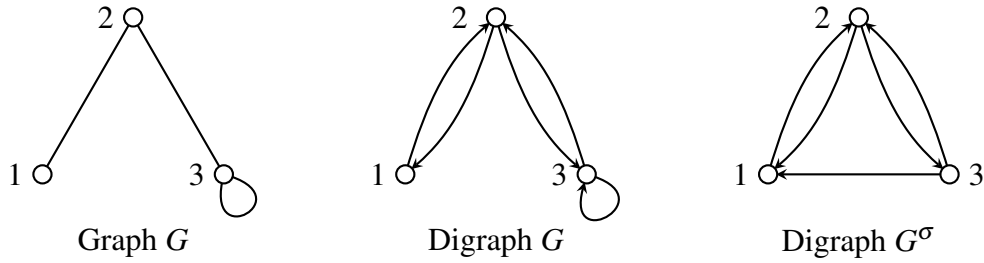

Figure 2.2: Example 2.5

Proof. Suppose π is a permutation of $V(G)$ for which G^π is a graph. Then

$$\begin{aligned}
 [a, a'] \in E(G) &\Leftrightarrow [a', a] \in E(G) && G \text{ is a graph} \\
 &\Leftrightarrow [a', \pi(a)] \in E(G^\pi) && \text{definition of permuted digraph} \\
 &\Leftrightarrow [\pi(a), a'] \in E(G^\pi) && G^\pi \text{ is a graph} \\
 &\Leftrightarrow [\pi(a), \pi^{-1}(a')] \in E(G) && \text{definition of permuted digraph.}
 \end{aligned}$$

Because $[a, a'] \in E(G)$ if and only if $[\pi(a), \pi^{-1}(a')] \in E(G)$, the permutation π is an anti-automorphism.

Conversely, suppose that $\pi \in \text{Ant}(G)$ and $[a, a'] \in E(G^\pi)$. Then

$$\begin{aligned}
 [a, a'] \in E(G^\pi) &\Leftrightarrow [a, \pi^{-1}(a')] \in E(G) && \text{definition of permuted digraph} \\
 &\Leftrightarrow [\pi^{-1}(a'), a] \in E(G) && G \text{ is a graph} \\
 &\Leftrightarrow [\pi(\pi^{-1}(a')), \pi^{-1}(a)] \in E(G) && \pi \in \text{Ant}(G) \\
 &\Leftrightarrow [a', \pi^{-1}(a)] \in E(G) \\
 &\Leftrightarrow [a', \pi(\pi^{-1}(a))] \in E(G^\pi) && \text{definition of permuted digraph} \\
 &\Leftrightarrow [a', a] \in E(G^\pi).
 \end{aligned}$$

Thus the digraph G^π is symmetric and so G^π is a graph. \square

EXAMPLE 2.7. Recall Example 2.3. Because α is an anti-automorphism, G^α is a graph. For instance, $[1,2] \in G$ and so $[1,\alpha(2)] = [1,3] \in E(G^\alpha)$. Likewise, $[3,4] \in E(G)$ and $[3,\alpha(4)] = [3,1] \in E(G^\alpha)$.

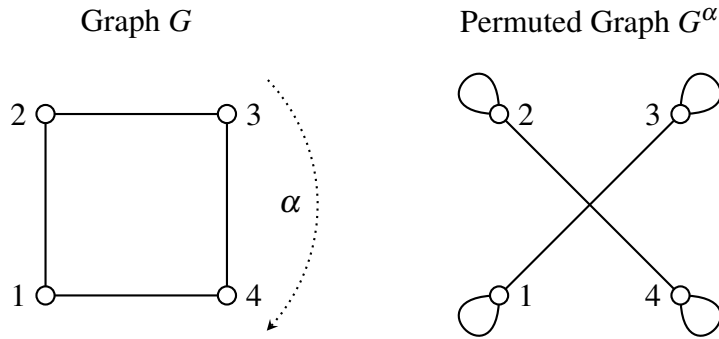

Figure 2.3: Example 2.7, Permuted graph G^α

2.2 The Direct Product and Anti-Automorphisms

In this section, we present several results by Lovász, building the machinery needed to prove Hammack's Proposition 2.14 which will characterize solutions of $G \times B \cong X \times B$. Characterizing solutions X of $G \times B \cong X \times B$ will aid us in characterizing cancellation graphs G .

DEFINITION 2.8. Let $\text{Hom}(X,A)$ denote the set of all homomorphisms $f : X \rightarrow A$. Let $\text{hom}(X,A) = |\text{Hom}(X,A)|$. Also, let $\text{Inj}(X,A)$ denote the set of all injective homomorphisms $g : X \rightarrow A$. Let $\text{inj}(X,A) = |\text{Inj}(X,A)|$.

LEMMA 2.9. Let X , G , and C be graphs. Then $\text{hom}(X, G \times C) = \text{hom}(X, G) \cdot \text{hom}(X, C)$. (See [3] [7].)

Proof. Let $\Phi : \text{Hom}(X, A \times C) \rightarrow \text{Hom}(X, A) \times \text{Hom}(X, C)$ such that $f \mapsto (\text{proj}_A f, \text{proj}_C f)$. It suffices to show that Φ is a bijection.

To show Φ is injective, suppose $\Phi(f) = \Phi(g)$. It follows that $(\text{proj}_A f, \text{proj}_C f) = (\text{proj}_A g, \text{proj}_C g)$. Hence, $\text{proj}_A f(x) = \text{proj}_A g(x)$ for all $x \in X$ and $\text{proj}_C f(x) = \text{proj}_C g(x)$ for all $x \in X$. Thus,

$$f(x) = (\text{proj}_A f(x), \text{proj}_C f(x)) = (\text{proj}_A g(x), \text{proj}_C g(x)) = g(x).$$

To show Φ is surjective, suppose that $(h, \ell) \in \text{Hom}(X, A) \times \text{Hom}(X, C)$. Define $f : X \rightarrow A \times C$ such that $f(x) = (h(x), \ell(x))$. Therefore, $\Phi(f) = (h, \ell)$. We need to show that $f \in \text{Hom}(X, A \times C)$. Notice that

$$\begin{aligned} [x, y] \in E(X) &\Leftrightarrow [h(x), h(y)] \in E(A), [\ell(x), \ell(y)] \in E(C) \quad \text{since } h \in \text{Hom}(X, A), \ell \in \text{Hom}(X, C) \\ &\Leftrightarrow [(h(x), \ell(x)), (h(y), \ell(y))] \in E(A \times C) \quad \text{by definition of direct product} \\ &\Leftrightarrow [f(x), f(y)] \in E(A \times C). \end{aligned}$$

Thus, $f \in \text{Hom}(X, A \times C)$. Because Φ is a bijection, then $\text{hom}(X, G \times C) = \text{hom}(X, G) \cdot \text{hom}(X, C)$. □

DEFINITION 2.10. Let X be a graph and Ω a partition of the vertices of X . Then the *quotient graph* X/Ω has vertex set Ω and edge set $\{[X_1, X_2] : \exists x_1 \in X_1, x_2 \in X_2 \text{ s.t. } [x_1, x_2] \in E(X)\}$.

EXAMPLE 2.11. Let G be the graph from Figure 2.4. Let $A = \{v_1, v_2, v_4, v_5\}$, $B = \{v_7, v_9, v_{11}\}$, $C = \{v_8, v_{10}, v_{12}\}$ and $D = \{v_3, v_6\}$ be sets of the vertices of G . Then $\Omega = \{A, B, C, D\}$ is a partition of $V(G)$ because each vertex of G is in exactly one of the sets in Ω . The quotient graph G/Ω is shown on the right of Figure 2.4.

We next will prove a classic result by Lovász, namely, that $A \cong B$ if and only if $\text{hom}(X, A) = \text{hom}(X, B)$ for all X . First, a lemma [3] [7].

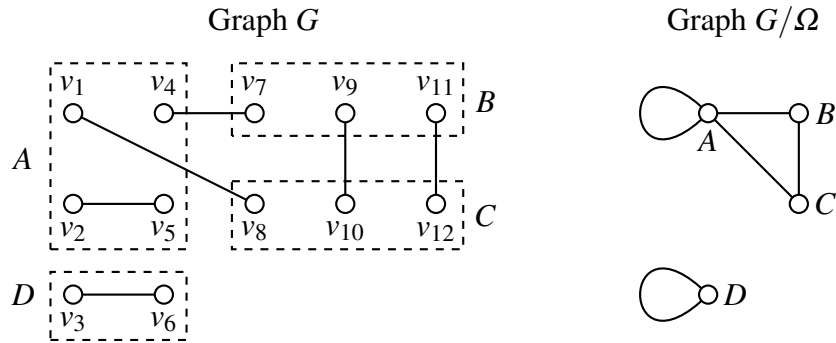
Figure 2.4: Example 2.11, Graphs G and G/Ω

LEMMA 2.12. Suppose X and A are graphs. Let \mathcal{P} be the set of all partitions of $V(X)$. Then

$$\text{hom}(X, A) = \sum_{\Omega \in \mathcal{P}} \text{inj}(X/\Omega, A).$$

Proof. Let $I = \{(f^*, \Omega) \mid f^* \in \text{Inj}(X/\Omega, A), \Omega \in \mathcal{P}\}$ and note that $|I| = \sum_{\Omega \in \mathcal{P}} \text{inj}(X/\Omega, A)$. Let $\gamma: \text{Hom}(X, A) \rightarrow I$ be the function such that $f \mapsto (f^*, \Omega_f)$ where $f^*: X/\Omega_f \rightarrow A$ is defined as $f^*(U) = f(u)$ for any $u \in U$ and $\Omega_f = \{f^{-1}(a) : a \in A\}$. We prove the lemma by showing that γ is a bijection.

To show γ is one-to-one: Suppose that $\gamma(f) = \gamma(f_1)$. Thus $(f^*, \Omega_f) = (f_1^*, \Omega_{f_1})$. Let $x \in X$. Because $\Omega_f = \Omega_{f_1}$, then there exists a $U \in \Omega_f$ and $U \in \Omega_{f_1}$ such that $x \in U$. Note that $f^*(U) = f(x)$ and $f_1^*(U) = f_1(x)$ by definition. Because $f^* = f_1^*$, it follows that

$$f(x) = f^*(U) = f_1^*(U) = f_1(x).$$

Therefore, $f(x) = f_1(x)$ for all $x \in X$ and so $f = f_1$. Thus, γ is injective.

To show γ is onto: Let $(f^*, \Omega) \in I$. We will show that there exists a homomorphism $f \in \text{Hom}(X, A)$ such that $\Omega = \Omega_f$ and $f(u) = f^*(U)$ for all $u \in U \in \Omega$.

Let $f : X \rightarrow A$ such that $x \mapsto f^*(U)$ for $x \in U \in \Omega$. Let $x, y \in V(X)$. Then x and y are both contained in sets of the partition Ω . Call such sets U and V respectively. Note that it is possible that $U = V$. Then,

$$\begin{aligned} [x, y] \in E(X) &\Leftrightarrow [U, V] \in E(X/\Omega) \\ &\Leftrightarrow [f^*(U), f^*(V)] \in E(A) && \text{because } f \in \text{Hom}(X/\Omega, A) \\ &\Leftrightarrow [f(x), f(y)] \in E(A) && \text{by definition of } f^*. \end{aligned}$$

Thus, f is a homomorphism from X to A . Therefore, γ is a bijection. □

The following is also due to Lovász [3].

THEOREM 2.13. Let A and B be finite graphs. Then $\text{hom}(X, A) = \text{hom}(X, B)$ for every graph X if and only if $A \cong B$.

Proof. Let A and B be graphs such that $\text{hom}(X, A) = \text{hom}(X, B)$ for every graph X .

First we will prove that $\text{inj}(X, A) = \text{inj}(X, B)$ by induction on $|X|$. Then we will show that this fact implies $A \cong B$.

Base case: Let $|X| = 1$. Then trivially

$$\text{inj}(X, A) = \text{hom}(X, A) = \text{hom}(X, B) = \text{inj}(X, B).$$

Inductive Hypothesis: Suppose that for $|X| \leq k$, it is true that $\text{hom}(X, A) = \text{hom}(X, B)$ implies $\text{inj}(X, A) = \text{inj}(X, B)$.

Inductive Step: Suppose $|X| = k + 1$. By Lemma 2.12, we know that $\text{hom}(X, A) = \text{hom}(X, B)$ implies that $\sum_{\Omega \in \mathcal{P}} \text{inj}(X/\Omega, A) = \sum_{\Omega \in \mathcal{P}} \text{inj}(X/\Omega, B)$. Let T be the trivial partition

of X . Hence $X/T = X$. Then

$$\text{inj}(X/T, A) + \sum_{\Omega \in \mathcal{P}-T} \text{inj}(X/\Omega, A) = \text{inj}(X/T, B) + \sum_{\Omega \in \mathcal{P}-T} \text{inj}(X/\Omega, B).$$

Note that for each $\Omega \in \mathcal{P} - T$, $|X/\Omega| < k + 1$. By the induction hypothesis, $\text{inj}(X/\Omega, A) = \text{inj}(X/\Omega, B)$ for all $\Omega \in \mathcal{P} - T$. Hence, $\sum_{\Omega \in \mathcal{P}-T} \text{inj}(X/\Omega, A) = \sum_{\Omega \in \mathcal{P}-T} \text{inj}(X/\Omega, B)$. It follows that $\text{inj}(X, A) = \text{inj}(X, B)$.

By the Principle of Induction, $\text{inj}(X, A) = \text{inj}(X, B)$ for all graphs X . Because $\text{inj}(A, A) = \text{inj}(A, B)$ and the identity function is an injective function from A to A , then $1 \leq \text{inj}(A, B)$. Thus there exists an injective homomorphism from A to B implying that $|E(A)| \leq |E(B)|$. Also because $\text{inj}(B, A) = \text{inj}(B, B)$ and the identity function is an injective function from B to B , then $1 \leq \text{inj}(B, A)$. Therefore, there exists an injective homomorphism from B to A implying that $|E(B)| \leq |E(A)|$. Therefore, $|E(A)| = |E(B)|$. Let $\phi \in \text{Inj}(A, B)$. Because $|E(A)| = |E(B)|$ then ϕ is an isomorphism and so $A \cong B$.

Conversely, suppose $A \cong B$. Then trivially, $\text{hom}(X, A) = \text{hom}(X, B)$. □

The following result by R. Hammack [5] shows that anti-automorphisms are critical in the search for solutions to $G \times B \cong X \times B$. We will continue to use the result throughout the rest of the paper.

PROPOSITION 2.14. Suppose that C is a zero divisor (i.e. bipartite graph). Then $G \times C \cong X \times C$ if and only if $X = G^\pi$ for some $\pi \in \text{Ant}(G)$.

Proof. Let C be a bipartite graph and G and X be graphs such that $G \times C \cong X \times C$.

First, we will prove that $G \times K_2 \cong X \times K_2$. Then we will use this simpler result to prove the proposition.

Because graph C is bipartite, there exists a homomorphism $K_2 \rightarrow C$. Let A be any graph. Because $G \times C \cong X \times C$ then $\text{hom}(A, G \times C) = \text{hom}(A, X \times C)$. By Lemma 2.9,

$$\text{hom}(A, G) \cdot \text{hom}(A, C) = \text{hom}(A, X) \cdot \text{hom}(A, C).$$

Either $\text{hom}(A, C) = 0$ or $\text{hom}(A, C) > 0$.

Case 1: Suppose that $\text{hom}(A, C) > 0$. Then it follows that $\text{hom}(A, G) = \text{hom}(A, X)$. We can multiply both sides of the equation by $\text{hom}(A, K_2)$ to get $\text{hom}(A, K_2) \cdot \text{hom}(A, G) = \text{hom}(A, K_2) \cdot \text{hom}(A, X)$. Lemma 2.9 implies that $\text{hom}(A, G \times K_2) = \text{hom}(A, X \times K_2)$.

Applying Lemma 2.13 gives us $G \times K_2 \cong X \times K_2$.

Case 2: Suppose that $\text{hom}(A, C) = 0$ implying there are no homomorphisms from A into C . This implies that there are no homomorphisms from A into K_2 . Otherwise, there would be a homomorphism from $A \rightarrow K_2 \rightarrow C$. Hence $\text{hom}(A, K_2) = 0$. Therefore,

$$\text{hom}(A, G) \cdot \text{hom}(A, K_2) = \text{hom}(A, X) \cdot \text{hom}(A, K_2).$$

Applying Lemma 2.9 we see that $\text{hom}(A, G \times K_2) = \text{hom}(A, X \times K_2)$. Applying Lemma 2.13 gives us $G \times K_2 \cong X \times K_2$.

By Proposition 1.26, there is an isomorphism $G \times K_2 \rightarrow X \times K_2$ with $(g, c) \mapsto (\phi(g, c), c)$. Define functions $\mu, \lambda : G \rightarrow X$ as $\mu(g) := \phi(g, 0)$ and $\lambda(g) := \phi(g, 1)$. Note that by construction, μ and λ are both bijective. First, we will show that $\mu^{-1}\lambda \in \text{Ant}(G)$. Then we will show $G^{\mu^{-1}\lambda} \cong X$.

$$\begin{aligned} [x, y] \in E(G) &\Leftrightarrow [(x, 0), (y, 1)] \in E(G \times K_2) && \text{definition of direct product} \\ &\Leftrightarrow [(\phi(x, 0), 0), (\phi(y, 1), 1)] \in E(X \times K_2) && \text{by isomorphism} \\ &\Leftrightarrow [(\mu(x), 0), (\lambda(y), 1)] \in E(X \times K_2) \\ &\Leftrightarrow [\mu(x), \lambda(y)] \in E(X) && \text{definition of direct product} \end{aligned}$$

Therefore $[x, y] \in E(G)$ if and only if $[\mu(x), \lambda(y)] \in E(X)$ (Fact 1). It follows that

$$\begin{aligned}
[x, y] \in E(G) &\Leftrightarrow [y, x] \in E(G) && G \text{ is symmetric} \\
&\Leftrightarrow [\mu(y), \lambda(x)] \in E(X) && \text{by Fact 1} \\
&\Leftrightarrow [\lambda(x), \mu(y)] \in E(X) && X \text{ is symmetric} \\
&\Leftrightarrow [\mu^{-1}(\lambda(x)), \lambda^{-1}(\mu(y))] \in E(G) && \text{from Fact 1} \\
&\Leftrightarrow [\mu^{-1}\lambda(x), (\mu^{-1}\lambda)^{-1}(y)] \in E(G).
\end{aligned}$$

Therefore, $\mu^{-1}\lambda \in \text{Ant}(G)$.

We claim that the function $\mu : G^{\mu^{-1}\lambda} \rightarrow X$ is an isomorphism.

Recall that μ is a bijection. To show μ is an isomorphism, it suffices to show that $[x, y] \in E(G^{\mu^{-1}\lambda})$ if and only if $[\mu(x), \mu(y)] \in E(X)$. Thus,

$$\begin{aligned}
[x, y] \in E(G^{\mu^{-1}\lambda}) &\Leftrightarrow [x, (\mu^{-1}\lambda)^{-1}(y)] \in E(G) \\
&\Leftrightarrow [x, \lambda^{-1}\mu(y)] \in E(G) \\
&\Leftrightarrow [\mu(x), \lambda\lambda^{-1}\mu(y)] \in E(X) && \text{by Fact 1} \\
&\Leftrightarrow [\mu(x), \mu(y)] \in E(X).
\end{aligned}$$

Hence, μ is an isomorphism and so $G^{\mu^{-1}\lambda} \cong X$.

Conversely, let $\alpha \in \text{Ant}(G)$ and G and X be graphs such that $G^\alpha \cong X$. Let C be a bipartite graph with partite sets C_0 and C_1 . It is sufficient to show that $G \times C \cong G^\alpha \times C$ for this surely implies that $G \times C \cong X \times C$.

Define $\Theta : G \times C \rightarrow G^\alpha \times C$ such that

$$\Theta(g, c) = \begin{cases} (g, c) & \text{if } c \in C_0 \\ (\alpha(g), c) & \text{if } c \in C_1. \end{cases}$$

Because α and the identity are bijective, Θ is also a bijection on the vertices of the graphs. We must show that $[(g, c), (h, c')] \in E(G \times C)$ if and only if $[\Theta(g, c), \Theta(h, c')] \in E(G^\alpha \times C)$.

Let $g, h \in V(G)$ and $c, c' \in V(C)$. Because C is bipartite, either $c \in C_0$ and $c' \in C_1$ or $c \in C_1$ and $c' \in C_0$.

Case 1: Suppose $c \in C_0$ and $c' \in C_1$. Then

$$\begin{aligned}
[(g, c), (h, c')] \in E(G \times C) &\Leftrightarrow [g, h] \in E(G) \text{ and } [c, c'] \in E(C) && \text{def. of direct product} \\
&\Leftrightarrow [g, \alpha(h)] \in E(G^\alpha) \\
&\Leftrightarrow [(g, c), (\alpha(h), c')] \in E(G^\alpha \times C) && \text{def. of direct product} \\
&\Leftrightarrow [\Theta(g, c), \Theta(h, c')] \in E(G^\alpha \times C) && \text{since } c \in C_0, c' \in C_1.
\end{aligned}$$

Case 2: Suppose $c \in C_1$ and $c' \in C_0$. Then

$$\begin{aligned}
[(g, c), (h, c')] \in E(G \times C) &\Leftrightarrow [g, h] \in E(G) \text{ and } [c, c'] \in E(C) && \text{def. of direct product} \\
&\Leftrightarrow [h, g] \in E(G) && G \text{ is symmetric} \\
&\Leftrightarrow [h, \alpha(g)] \in E(G^\alpha) \\
&\Leftrightarrow [\alpha(g), h] \in E(G^\alpha) && G^\alpha \text{ is a graph} \\
&\Leftrightarrow [(\alpha(g), c), (h, c')] \in E(G^\alpha \times C) && \text{def. of direct product} \\
&\Leftrightarrow [\Theta(g, c), \Theta(h, c')] \in E(G^\alpha \times C) && \text{since } c \in C_1, c' \in C_0.
\end{aligned}$$

In both cases, $[(g, c), (h, c')] \in E(G \times C)$ if and only if $[\Theta(g, c), \Theta(h, c')] \in E(G^\alpha \times C)$.

Therefore, Θ is an isomorphism and so $G \times C \cong G^\alpha \times C$ which implies that $G \times C \cong X \times C$.

□

2.3 The Factorial

By Proposition 2.14 finding solutions of $G \times B \cong X \times B$ is equivalent to finding G^α where $\alpha \in \text{Ant}(G)$. We would like to know when $G^\alpha \cong G^\beta$ for anti-automorphisms α and β . The following ideas were first introduced by R. Hammack and K. Toman in [6] and further explored by Hammack in [4].

DEFINITION 2.15. The *factorial of graph G* , notated by $G!$ is a digraph whose vertices are the permutations of $V(G)$, and $[\mu, \lambda]$ is a directed edge of $G!$ if and only if $[\mu(x), \lambda(y)] \in E(G)$ for every $[x, y] \in E(G)$.

PROPOSITION 2.16. The factorial of graph G is itself a graph.

Proof. Let $[\mu, \lambda] \in G!$. Then,

$$\begin{aligned} [x, y] \in E(G) &\Leftrightarrow [y, x] \in E(G) && \text{symmetry of } G \\ &\Leftrightarrow [\mu(y), \lambda(x)] \in E(G) && \text{definition of } G! \\ &\Leftrightarrow [\lambda(x), \mu(y)] \in E(G) && \text{symmetry of } G \end{aligned}$$

Because $[x, y] \in E(G)$ if and only if $[\lambda(x), \mu(y)] \in E(G)$, then $[\lambda, \mu]$ is a directed edge of $G!$. Therefore, $G!$ is symmetric and thus $G!$ is a graph. \square

Notice that for $\gamma \in \text{Aut}(G)$, the loop $[\gamma, \gamma]$ is in the directed edge set of $G!$. Also, for every anti-automorphism α of G , we see $[\alpha, \alpha^{-1}] \in E(G!)$.

Let $[\mu, \lambda] \in E(G!)$ and $[x, y] \in E(G)$. It follows that $[\mu(x), \lambda(y)]$ is an edge of G . Furthermore, $[\mu^{-1}(\mu(x)), \lambda^{-1}(\lambda(y))] = [x, y]$ is also an edge of G . Hence $[\mu^{-1}, \lambda^{-1}]$ is an edge of $G!$.

EXAMPLE 2.17. Consider the graph H illustrated in Figure 2.5, the three-cycle with a loop at one vertex. The vertex set of $H!$ is just S_3 , the symmetric group on $V(H)$. Thus $V(H!) =$

$\{\text{id}, (1\ 2), (1\ 3), (2\ 3), (1\ 2\ 3), (1\ 3\ 2)\}$. There are thirty-six pairs of these permutations and one can easily check each pair on each edge of H to see that there are only two edges of $H!$ which are $[(1\ 3), (1\ 3)]$ and $[\text{id}, \text{id}]$.

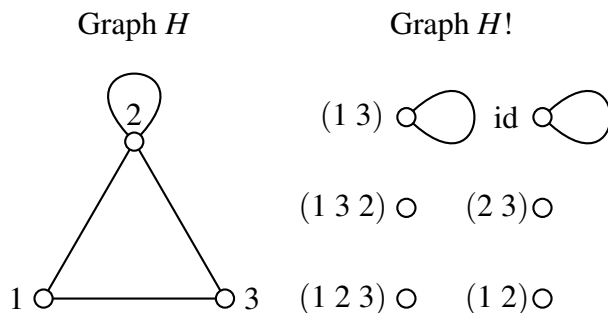

Figure 2.5: Example 2.17, Graph H and Factorial $H!$

Note that for $|V(G)| = n$, the order of $V(G!)$ is $n!$. In general, when picturing the factorial, we show only vertices of $G!$ that are incident to an edge though it is understood that $V(G!) = S_{V(G)}$.

The edges of $G!$ have some nice properties.

PROPOSITION 2.18. The edge set $E(G!)$ is a group with multiplication of function composition $[\mu, \lambda][\alpha, \beta] = [\mu\alpha, \lambda\beta]$.

Proof. First, note that for all $[x, y] \in E(G)$ it follows that $[\text{id}(x), \text{id}(y)] \in E(G)$. Hence, $[\text{id}, \text{id}] \in E(G!)$. Clearly, $[\text{id}, \text{id}]$ is the identity element of $E(G!)$.

Second, we show that $E(G!)$ is closed under multiplication: Let $[\alpha, \beta], [\mu, \lambda] \in E(G!)$.

Then

$$\begin{aligned} [x, y] \in E(G) &\Leftrightarrow [\mu(x), \lambda(y)] \in E(G) \\ &\Leftrightarrow [\alpha(\mu(x)), \beta(\lambda(y))] \in E(G) \\ &\Leftrightarrow [\alpha\mu, \beta\lambda] \in E(G!). \end{aligned}$$

Third, we show that $E(G!)$ is associative: Let $[\alpha, \beta], [\mu, \lambda], [\sigma, \gamma] \in E(G!)$.

$$\begin{aligned}
 [\alpha, \beta]([\mu, \lambda][\sigma, \gamma]) &= [\alpha, \beta][\mu\sigma, \lambda\gamma] \\
 &= [\alpha\mu\sigma, \beta\lambda\gamma] \\
 &= [\alpha\mu, \beta\lambda][\sigma, \gamma] \\
 &= ([\alpha, \beta][\mu, \lambda])[\sigma, \gamma].
 \end{aligned}$$

Therefore, $E(G!)$ is a group. □

PROPOSITION 2.19. The group $E(G!)$ acts on $\text{Ant}(G)$ as $[\mu, \lambda].\pi = \mu\pi\lambda^{-1}$.

Proof. Let $[\mu, \lambda], [\nu, \gamma] \in E(G!)$. It follows that

$$\begin{aligned}
 [\mu, \lambda].([\nu, \gamma].\pi) &= [\mu, \lambda].\nu\pi\gamma^{-1} \\
 &= \mu\nu\pi\gamma^{-1}\lambda^{-1} \\
 &= \mu\nu\pi(\lambda\gamma)^{-1} \\
 &= [\mu\nu, \lambda\gamma].\pi \\
 &= [\mu, \lambda][\nu, \gamma].\pi.
 \end{aligned}$$

Also note that $[id, id].\pi = id\pi id^{-1} = \pi$. Thus the edges of $G!$ form a group action on the anti-automorphisms of G . □

DEFINITION 2.20. Define a relation \simeq on $\text{Ant}(G)$ in the following way: for $\alpha, \beta \in \text{Ant}(G)$ we say $\alpha \simeq \beta$ if and only if there exists $[\mu, \lambda] \in E(G!)$ such that $[\mu, \lambda].\alpha = \beta$. In other words, $\alpha \simeq \beta$ if and only if α and β are in the same $E(G!)$ -orbit.

The following proposition asserts that the edges of $E(G!)$ determine the conditions under which we have $G^\alpha \cong G^\beta$.

PROPOSITION 2.21. If $\alpha, \beta \in \text{Ant}(G)$, then $\alpha \simeq \beta$ if and only if $G^\alpha \cong G^\beta$.

Proof. Suppose that $\alpha \simeq \beta$. Then there exists $[\mu, \lambda] \in E(G!)$ such that $[\mu, \lambda].\alpha = \beta$. Thus

$$\begin{aligned}\mu\alpha\lambda^{-1} &= \beta \\ (\mu\alpha\lambda^{-1})^{-1} &= \beta^{-1} \\ \lambda\alpha^{-1}\mu^{-1} &= \beta^{-1} \\ \alpha^{-1}\mu^{-1} &= \lambda^{-1}\beta^{-1}.\end{aligned}\tag{1.1}$$

Consider $\mu^{-1} : G^\beta \rightarrow G^\alpha$. We know that this is a bijection so we must show that μ^{-1} is an isomorphism. Observe that

$$\begin{aligned}[x, y] \in E(G^\beta) &\Leftrightarrow [x, \beta^{-1}(y)] \in E(G) \\ &\Leftrightarrow [\mu^{-1}(x), \lambda^{-1}(\beta^{-1}(y))] \in E(G) \quad \text{because } [\mu^{-1}, \lambda^{-1}] \in E(G!) \text{ as well} \\ &\Leftrightarrow [\mu^{-1}(x), \alpha^{-1}\mu^{-1}(y)] \in E(G) \quad \text{by (1.1)} \\ &\Leftrightarrow [\mu^{-1}(x), \mu^{-1}(y)] \in E(G^\alpha).\end{aligned}$$

Therefore, μ^{-1} is an isomorphism and so $G^\alpha \cong G^\beta$.

Conversely, suppose that $G^\alpha \cong G^\beta$. Then there exists an isomorphism $\gamma : G^\alpha \rightarrow G^\beta$.

Note that

$$\begin{aligned}[x, y] \in E(G) &\Leftrightarrow [x, \alpha(y)] \in E(G^\alpha) \\ &\Leftrightarrow [\gamma(x), \gamma(\alpha(y))] \in E(G^\beta) \\ &\Leftrightarrow [\gamma(x), \beta^{-1}(\gamma(\alpha(y)))] \in E(G).\end{aligned}$$

Therefore $[\gamma, \beta^{-1}\gamma\alpha] \in E(G!)$. Moreover,

$$\begin{aligned} [\gamma, \beta^{-1}\gamma\alpha].\alpha &= \gamma\alpha(\beta^{-1}\gamma\alpha)^{-1} \\ &= \gamma\alpha\alpha^{-1}\gamma^{-1}\beta \\ &= \beta. \end{aligned}$$

Therefore, $\alpha \simeq \beta$. □

EXAMPLE 2.22. Consider graph G from Example 2.3. First, note that $(1\ 2)(3\ 4)$ is an automorphism of G . Then we can find $G^{(1\ 2)(3\ 4)}$ as pictured in Figure 2.6.

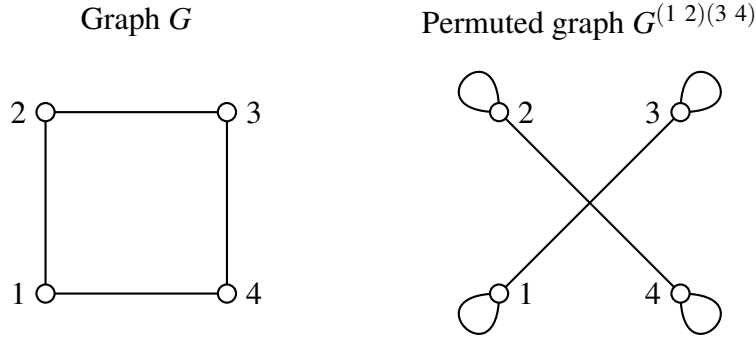

Figure 2.6: Example 2.22, Permuted graph $G^{(1\ 2)(3\ 4)}$

Referring back to Figure 2.3, note that $G^{(1\ 2)(3\ 4)} \cong G^\alpha$. Proposition 2.21 tells us that $\alpha = (1\ 2\ 3\ 4) \simeq (1\ 2)(3\ 4)$; we will check to see that this holds for G . The reader can check that $[\text{id}, (2\ 4)] \in E(G!)$. Then, $[\text{id}, (2\ 4)].(1\ 2\ 3\ 4) = (1\ 2\ 3\ 4)(2\ 4) = (1\ 2)(3\ 4)$. By definition of \simeq , we have shown $\alpha \simeq (1\ 2)(3\ 4)$.

Putting together Proposition 2.14 ($G \times B \cong X \times B \Leftrightarrow X \cong G^\alpha$) along with the equivalence relation \simeq and Proposition 2.21 ($\alpha \simeq \beta \Leftrightarrow G^\alpha \cong G^\beta$) gives us the isomorphism equivalence classes of solutions for $G \times B \cong X \times B$ as $\{[G_1^\alpha], [G_2^\alpha], \dots, [G_n^\alpha]\}$ where each α_i is from a unique equivalence class of \simeq . Consider our ultimate goal of characterizing cancellation graphs which are graphs G with the property that $G \times B \cong X \times B$ implies $G \cong X$.

Therefore, G must have one equivalence class of solutions, $[G^{\text{id}}]$. Every anti-automorphism of cancellation graph G must be in the same $E(G!)$ -orbit as the identity. In chapter 3, we will push these ideas further to get a tighter characterization of bipartite cancellation graphs.

Finding the factorial of a graph and all of the equivalence classes of the solutions is a difficult problem in general. The following proposition narrows the permutations of $V(G)$ we must consider to find the edges of $G!$.

PROPOSITION 2.23. Suppose G is a connected graph with $[f, g] \in E(G!)$. For each vertex x of graph G , we have $\deg(x) = \deg(f(x)) = \deg(g(x))$.

Proof. Let $x \in V(G)$ and $\deg(x) = n$ with neighbors v_1, v_2, \dots, v_n . For $1 \leq i \leq n$, we have $[f, g][x, v_i] = [f(x), g(v_i)]$ which is an edge in G . Since g is a bijection on the vertices of G , it follows that $g(v_i) = g(v_j)$ if and only if $i = j$. Therefore, $f(x)$ has at least n neighbors: $g(v_1), g(v_2), \dots, g(v_n)$. Thus, $\deg(x) \leq \deg(f(x))$.

Likewise, $[f, g][v_i, x] = [f(v_i), g(x)]$ is an edge in G . Since f is a bijection on the vertices of G , each $f(v_i)$ is unique and so $g(x)$ has at least n neighbors: $f(v_1), f(v_2), \dots, f(v_n)$. Thus $\deg(x) \leq \deg(g(x))$.

Since $[f, g] \in E(G!)$, a group, it follows that $[f^{-1}, g^{-1}] \in E(G!)$. Let $\deg(f(x)) = m$ and the neighbors of $f(x)$ be u_1, u_2, \dots, u_m . For $1 \leq j \leq m$, it follows that $[f^{-1}, g^{-1}][f(x), u_j] = [f^{-1}(f(x)), g^{-1}(u_j)] = [x, g^{-1}(u_j)]$ which is an edge of G . Since g^{-1} is a bijection on $V(G)$, each $g^{-1}(u_j)$ is unique and so x has at least m neighbors: $g^{-1}(u_1), g^{-1}(u_2), \dots, g^{-1}(u_m)$. Thus $\deg(f(x)) \leq \deg(x)$.

Finally, let $\deg(g(x)) = k$ and the neighbors of $g(x)$ be w_1, w_2, \dots, w_k . For $1 \leq \ell \leq k$, it follows that $[f^{-1}, g^{-1}][w_\ell, g(x)] = [f^{-1}(w_\ell), g^{-1}(g(x))] = [f^{-1}(w_\ell), x]$ which is an edge of G . Since f^{-1} is a bijection on the vertices of G , each $f^{-1}(w_\ell)$ is unique and so x has at least ℓ neighbors: $f^{-1}(w_1), f^{-1}(w_2), \dots, f^{-1}(w_\ell)$. Thus $\deg(g(x)) \leq \deg(x)$.

Therefore, we can write $\deg(x) = \deg(g(x)) = \deg(f(x))$. □

Recall Example 2.17. Using Proposition 2.23, we eliminate much of the work to find $H!$. We can only permute vertices 1 and 3 among themselves and we can only send vertex 2 to itself. Thus the only permutations that are possibly incident to edges in $H!$ are id and $(1\ 3)$.

The following proposition shows that certain powers of anti-automorphisms are in the same equivalence class of solutions X of $G \times B \cong X \times B$, simplifying the process of finding all solutions.

PROPOSITION 2.24. If $\alpha \in \text{Ant}(G)$ then $G^{\alpha^k} \cong G^{\alpha^{k+2n}}$ for non-negative integers k and n .

Proof. We prove this by induction on n . Let $\alpha \in \text{Ant}(G)$. Then, $\alpha^k \in \text{Ant}(G)$. Also, $[\alpha, \alpha^{-1}] \in E(G!)$.

Base step: By the group action, $[\alpha, \alpha^{-1}].\alpha^k = \alpha\alpha^k(\alpha^{-1})^{-1} = \alpha^{k+2}$. Therefore, $\alpha^k \simeq \alpha^{k+2}$ and so $G^{\alpha^k} \cong G^{\alpha^{k+2}}$.

Inductive step: Suppose that $\alpha^k \simeq \alpha^{k+2m}$. By the group action, $[\alpha, \alpha^{-1}].\alpha^{k+2m} = \alpha\alpha^k(\alpha^{-1})^{-1} = \alpha^{k+2m+2} = \alpha^{k+2(m+1)}$. Therefore, $\alpha^{k+2m} \simeq \alpha^{k+2(m+1)}$. It follows that $\alpha^k \simeq \alpha^{k+2(m+1)}$ and so $G^{\alpha^k} \cong G^{\alpha^{k+2(m+1)}}$.

By the Principle of Induction, $G^{\alpha^k} \cong G^{\alpha^{k+2n}}$ is true for all $n \in \mathbb{N}$. □

The following corollary follows directly from Proposition 2.24.

COROLLARY 2.25. If α has odd order, then $G^\alpha \cong G$.

PROPOSITION 2.26. If $\alpha \in \text{Ant}(G)$ has order n and $n \not\equiv 0 \pmod{4}$ then α is in the same $E(G!)$ -orbit as some $\beta \in \text{Ant}(G)$ such that β is an involution or $\beta = \text{id}$.

Proof. Let $\alpha \in \text{Ant}(G)$ and n be the order of α which implies $\alpha^n = \text{id}$. Either n is odd or n is even.

Case 1: Suppose that n is odd, $n = 1 + 2m$ for non-negative m . Then $\alpha^{1+2m} = \text{id}$. By Proposition 2.24, we have $\alpha \simeq \alpha^{1+2m} = \text{id}$. Therefore, α is in the same $E(G!)$ -orbit as id.

Case 2: Suppose that n is even. Since $n \not\equiv 0 \pmod{4}$, then $n = 2 + 4m$ for some non-negative m . Thus $\alpha^{2+4m} = \text{id}$. Note that $(\alpha^{1+2m})^2 = \alpha^{2+4m} = \text{id}$ which implies that α^{1+2m} is an involution. From Proposition 2.24, we have $\alpha \simeq \alpha^{1+2m}$. Therefore, α is in the same $E(G!)$ -orbit as involution α^{1+2m} . \square

Proposition 2.26 reduces finding the solutions of $G \times B \cong X \times B$ to finding involutions of G and anti-automorphisms of order 2^m . Practically, involutions are “easier” to identify in a given graph. In the next chapters we will seek to find means to handle the anti-automorphisms of order 2^m in order to find all solutions of $G \times B \cong X \times B$.

Bipartite Cancellation Graphs

We will classify all solutions X of $G \times B \cong X \times B$ where B and G are connected bipartite graphs. Moreover, we will classify those G for which the solution X is unique. Hence, we will classify all bipartite cancellation graphs G . That is, all such graphs G such that $G \times C \times X \times C$ implies $G \cong X$ for all graphs C .

3.1 Anti-Automorphisms and Bipartite Graphs

Given a graph G , the following proposition is useful for identifying possible pairs of permutations of G which are possibly adjacent in the factorial $G!$. Simplifying the process of finding $G!$ will in turn help us to find the $E(G!)$ -orbits of the anti-automorphisms of G . First, we give a definition.

DEFINITION 3.1. Let f be a permutation of the vertices of bipartite graph B with partite sets X and Y . Permutation f *preserves the bipartition* of B if $f(x) \in X$ for all $x \in X$ and $f(y) \in Y$ for all $y \in Y$. We say f *reverses the bipartition* if $f(x) \in Y$ for all $x \in X$ and $f(y) \in X$ for all $y \in Y$.

PROPOSITION 3.2. If $[f, g]$ is an arc of $G!$ and G is bipartite and connected then f and g either both preserve the bipartition or both reverse the bipartition.

Proof. Let G be a bipartite graph with partite sets X and Y . Suppose to the contrary that there exists edge $[f, g] \in E(G!)$ such that f and g do not both preserve the bipartition of G

nor reverse the bipartition of G . Without loss of generality there exists an $x \in X$ such that f preserves the bipartition at x and g reverses the bipartition at x . Hence, $f(x) \in X$ and $g(x) \in Y$. Because G is connected and $f(x)$ and $g(x)$ are in different partite sets, there exists a path of odd length: $f(x), v_1, v_2, \dots, v_\ell, g(x)$ for even ℓ . Recall that $[g^{-1}, f^{-1}]$ and $[f^{-1}, g^{-1}]$ are both edges of $E(G!)$. It follows that $[f^{-1}(f(x)), g^{-1}(v_1)], [g^{-1}(v_1), f^{-1}(v_2)], \dots, [f^{-1}(v_\ell), g^{-1}(g(x))] \in E(G)$. Therefore, $x, g^{-1}(v_1), f^{-1}(v_2), \dots, f^{-1}(v_\ell), x$ is an x - x walk in G of odd length. But every walk in G which starts and ends in the same partite set must be even. So, the odd length of the walk contradicts that G is bipartite.

Thus, every directed edge of $G!$ must preserve or reverse the bipartition of G . \square

The difficulty of the task of finding the factorial escalates as the number of vertices of the graph increases. We seek to build more tools to make the process more manageable in general. First, consider the following example. We will revisit this example through the remainder of the chapter.

EXAMPLE 3.3. Consider the graph G from Figure 3.1. We will find the factorial of G .

Let's consider several permutations of the vertices of G : α , rotation by 90° ; μ , reflection across the vertical axis of symmetry; λ , reflection across the horizontal axis of symmetry; δ , reflection across the positive sloped diagonal; and ε , reflection across the negative sloped diagonal. Note that these permutations have order two except for α which has order four. Notice that permutations α^2 , μ , and λ all map the edges of G to edges of G and are thus automorphisms. Hence each of these permutations will correspond to a loop in $G!$.

Also, note that for every edge

$$[x, y] \in E(G), [\alpha(x), \alpha^{-1}(y)], [\alpha^{-1}(x), \alpha(y)], [\varepsilon(x), \delta(y)], [\delta(x), \varepsilon(y)] \in E(G).$$

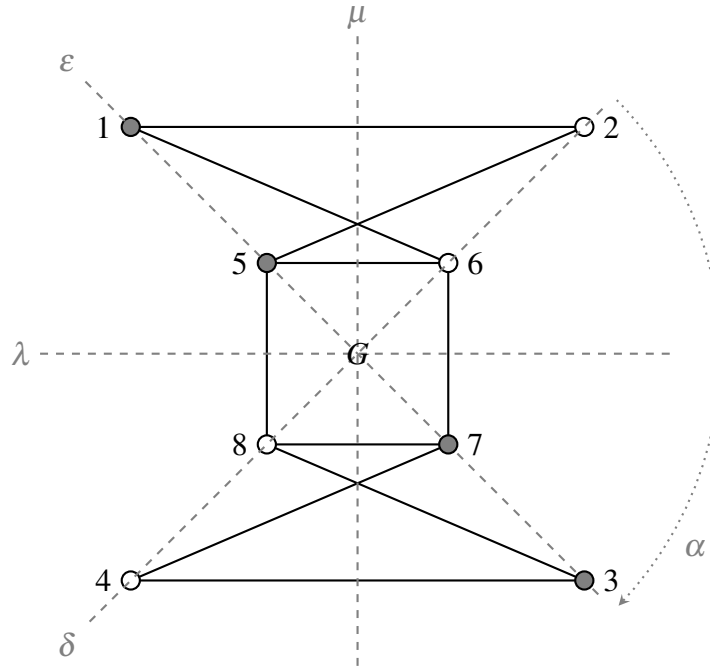
Figure 3.1: Example 3.3, Graph G

This implies that $[\alpha, \alpha^{-1}], [\alpha^{-1}, \alpha], [\varepsilon, \delta], [\delta, \varepsilon] \in E(G!)$. Further study of these reflections and rotations of G reveals the following multiplication table. Thus these edges of $G!$

\circ	$[i, i]$	$[\mu, \mu]$	$[\lambda, \lambda]$	$[\alpha^2, \alpha^2]$	$[\alpha, \alpha^{-1}]$	$[\alpha^{-1}, \alpha]$	$[\varepsilon, \delta]$	$[\delta, \varepsilon]$
$[i, i]$	$[i, i]$	$[\mu, \mu]$	$[\lambda, \lambda]$	$[\alpha^2, \alpha^2]$	$[\alpha, \alpha^{-1}]$	$[\alpha^{-1}, \alpha]$	$[\varepsilon, \delta]$	$[\delta, \varepsilon]$
$[\mu, \mu]$	$[\mu, \mu]$	$[i, i]$	$[\alpha^2, \alpha^2]$	$[\lambda, \lambda]$	$[\varepsilon, \delta]$	$[\delta, \varepsilon]$	$[\alpha, \alpha^{-1}]$	$[\alpha^{-1}, \alpha]$
$[\lambda, \lambda]$	$[\lambda, \lambda]$	$[\alpha^2, \alpha^2]$	$[i, i]$	$[\mu, \mu]$	$[\delta, \varepsilon]$	$[\varepsilon, \delta]$	$[\alpha^{-1}, \alpha]$	$[\alpha, \alpha^{-1}]$
$[\alpha^2, \alpha^2]$	$[\alpha^2, \alpha^2]$	$[\lambda, \lambda]$	$[\mu, \mu]$	$[i, i]$	$[\alpha^{-1}, \alpha]$	$[\alpha, \alpha^{-1}]$	$[\delta, \varepsilon]$	$[\varepsilon, \delta]$
$[\alpha, \alpha^{-1}]$	$[\alpha, \alpha^{-1}]$	$[\delta, \varepsilon]$	$[\varepsilon, \delta]$	$[\alpha^{-1}, \alpha]$	$[\alpha^2, \alpha^2]$	$[i, i]$	$[\mu, \mu]$	$[\lambda, \lambda]$
$[\alpha^{-1}, \alpha]$	$[\alpha^{-1}, \alpha]$	$[\varepsilon, \delta]$	$[\delta, \varepsilon]$	$[\alpha, \alpha^{-1}]$	$[i, i]$	$[\alpha^2, \alpha^2]$	$[\lambda, \lambda]$	$[\mu, \mu]$
$[\varepsilon, \delta]$	$[\varepsilon, \delta]$	$[\alpha^{-1}, \alpha]$	$[\alpha, \alpha^{-1}]$	$[\delta, \varepsilon]$	$[\lambda, \lambda]$	$[\mu, \mu]$	$[i, i]$	$[\alpha^2, \alpha^2]$
$[\delta, \varepsilon]$	$[\delta, \varepsilon]$	$[\alpha, \alpha^{-1}]$	$[\alpha^{-1}, \alpha]$	$[\varepsilon, \delta]$	$[\mu, \mu]$	$[\lambda, \lambda]$	$[\alpha^2, \alpha^2]$	$[i, i]$

Table 3.1: Multiplication table of group $E(G!)$ for Example 3.3

form a subgroup of $E(G!)$. We must check that these are the only edges of $E(G!)$.

Using Proposition 2.23, we see that any permutation which is incident to an edge in $G!$ must permute the outer vertices to outer vertices and inner vertices to inner vertices of

graph G . By Proposition 3.2, we can further narrow down the permutations by looking at permuting the partite sets.

First, we look at permutations which reverse the bipartition. The reader can verify that each permutation which is adjacent to an edge in $G!$ must permute the inner vertices in one of the following ways: $(5\ 6\ 7\ 8)$, $(5\ 8\ 7\ 6)$, $(5\ 6)(7\ 8)$, $(5\ 8)(7\ 6)$. Similarly, the permutations contained in an edge of $G!$ must permute the outer vertices in one of the following ways: $(1\ 2)(3\ 4)$, $(1\ 2\ 3\ 4)$, $(1\ 4\ 3\ 2)$, $(1\ 4)(2\ 3)$.

Second, we look at permutations which preserve the bipartition. The permutations which are adjacent to an edge in $G!$ must permute the inner vertices in one of the following ways: i , $(6\ 8)$, $(5\ 7)$, $(5\ 7)(6\ 8)$. Such permutations must also permute the outer vertices in one of the following ways: i , $(1\ 3)(2\ 4)$, $(1\ 3)$, $(2\ 4)$.

Looking at these possibilities, how they permute the vertices of G , the reader can confirm that the only edges of $G!$ are $[i, i]$, $[\mu, \mu]$, $[\lambda, \lambda]$, $[\alpha^2, \alpha^2]$, $[\alpha, \alpha^{-1}]$, $[\alpha^{-1}, \alpha]$, $[\varepsilon, \delta]$ and $[\delta, \varepsilon]$. For example, consider σ , such that $\sigma|_{\{1,2,3,4\}} = (1\ 2\ 3\ 4)$. Suppose that γ is another permutation such that for all $[x, y] \in E(G)$, $[\sigma(x), \gamma(y)] \in E(G)$. By Propositions 3.2 and 2.23, we see that $[\sigma(1), \gamma(6)] = [2, 5]$, $[\sigma(2), \gamma(5)] = [3, 8]$, $[\sigma(3), \gamma(8)] = [4, 7]$, and $[\sigma(4), \gamma(7)] = [3, 8]$. Thus we know that $\gamma|_{\{5,6,7,8\}} = (5\ 8\ 7\ 6)$. Furthermore, by the Propositions 3.2 and 2.23, the following relations are forced: $[\sigma(2), \gamma(1)] = [2, 1]$, $[\sigma(2), \gamma(1)] = [3, 4]$, $[\sigma(3), \gamma(4)] = [4, 3]$, and $[\sigma(4), \gamma(3)] = [1, 2]$. This reveals that $\gamma = (1\ 4\ 3\ 2)(5\ 8\ 7\ 6)$. Finally, we have the following mappings:

$$[\sigma(5), \gamma(2)] = [6, 1], \quad [\sigma(6), \gamma(1)] = [7, 4], \quad [\sigma(7), \gamma(4)] = [8, 3], \quad \text{and} \quad [\sigma(8), \gamma(3)] = [5, 2].$$

Thus $\sigma = (1\ 2\ 3\ 4)(5\ 6\ 7\ 8)$. Note that $[\sigma, \gamma]$ is the only edge in $G!$ such that one of the vertices permutes the outer vertices of G in the manner of $(1\ 2\ 3\ 4)$. The labeling of G in Figure 3.1 reveals that $\sigma = \alpha$ and $\gamma = \alpha^{-1}$.

Following the same procedure with the other possible permutations reveals that all edges of $G!$ have been accounted for in our multiplication table and there are exactly 8 edges in $G!$. Notice that

$$E(G!) := \langle [\alpha, \alpha^{-1}], [\mu, \mu] : [\alpha, \alpha^{-1}] = [\mu\mu]^2 = [i, i], [\mu\mu][\alpha, \alpha^{-1}][\mu, \mu] = [\alpha^{-1}, \alpha] \rangle.$$

Therefore, $E(G!) \cong D_8$, the dihedral group of the square.

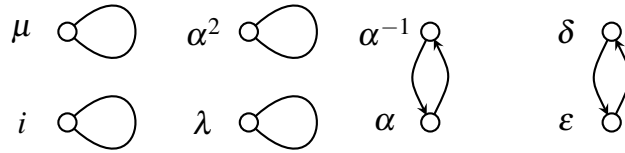

Figure 3.2: Example 3.3, Graph $G!$

PROPOSITION 3.4. Suppose that G is connected and bipartite. Suppose that $\alpha \in \text{Ant}(G)$ preserves the bipartition. Then $G^\alpha \cong G$.

Proof. Let G be a bipartite graph with partite sets X and Y . Let $\alpha \in \text{Ant}(G)$. Define $\mu : V(G) \rightarrow V(G)$ so that $\mu|_X = \alpha^{-1}$ and $\mu|_Y = \text{id}$. Likewise, define $\lambda : V(G) \rightarrow V(G)$ so that $\lambda|_X = \text{id}$ and $\lambda|_Y = \alpha$. We claim that $[\mu, \lambda] \in E(G!)$. Let $[x, y] \in E(G)$. Since G is bipartite, then the vertices must be in different partite sets. Say $x \in X$ and $y \in Y$. Then,

$$\begin{aligned} [x, y] \in E(G) &\Leftrightarrow [\alpha^{-1}(x), \alpha(y)] \in E(G) && \text{by def. of anti-automorphism} \\ &\Leftrightarrow [\mu(x), \lambda(y)] \in E(G) \end{aligned}$$

On the other hand, if $x \in Y$ and $y \in X$, then

$$\begin{aligned} [x, y] \in E(G) &\Leftrightarrow [\text{id}(x), \text{id}(y)] \in E(G) \\ &\Leftrightarrow [\lambda(x), \mu(y)] \in E(G) && \text{by def. of } \mu \text{ and } \lambda \end{aligned}$$

Therefore, $[\mu, \lambda] \in E(G!)$.

Now we consider $[\mu, \lambda].\alpha = \mu\alpha\lambda^{-1}$. Let $x \in X$. Then $\mu\alpha\lambda^{-1}(x) = \alpha^{-1}\alpha(x) = x$. Let $y \in Y$. Then $\mu\alpha\lambda^{-1}(y) = \text{id}\alpha\alpha^{-1}(y) = y$. Thus $\mu\alpha\lambda^{-1}$ acts as the identity on all vertices in G . Hence $\mu\alpha\lambda^{-1} = \text{id}$ and so $\alpha \simeq \text{id}$. Therefore, $G \cong G^\alpha$. \square

EXAMPLE 3.5. Note that in Example 3.3, the involution α^2 preserves the bipartition; α^2 maps the gray vertices to the gray vertices and the white vertices to the white vertices. Finding G^{α^2} reveals that $G^{\alpha^2} \cong G$.

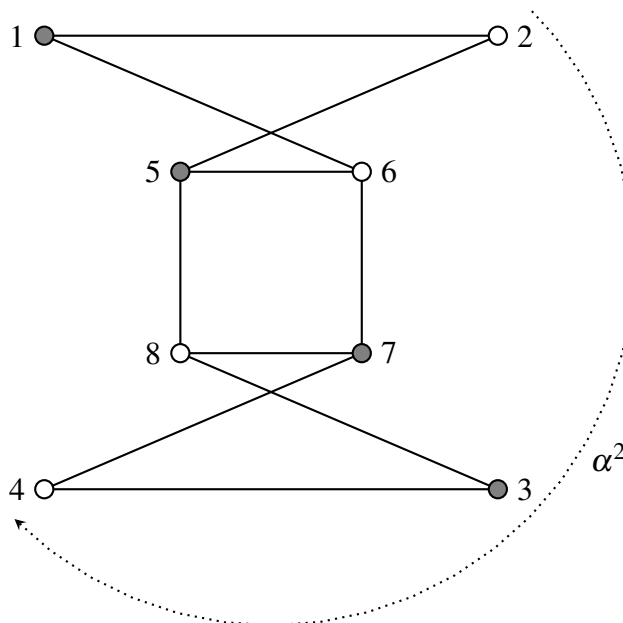

Figure 3.3: Example 3.5, Graph G^{α^2}

In the effort of finding all solutions of $G \times B \cong X \times B$ when G and B are connected bipartite graphs (and characterizing bipartite cancellation graphs), we can ignore all anti-automorphisms that preserve the bipartition because they are in the same equivalence class of solutions as $X = G$.

LEMMA 3.6. Let G be a connected bipartite graph with partite sets X and Y and $\alpha \in \text{Ant}(G)$ such that α reverses the bipartition. Then G^α has 2 components such that one component contains all vertices of X and one component contains all vertices of Y .

Proof. Let G be a connected bipartite graph with partite sets X and Y . Let $\alpha \in \text{Ant}(G)$ such that α reverses the bipartition. First, we will show that in G^α , vertices in X are not connected to vertices in Y . Assume to the contrary that there exists $[x, y] \in G^\alpha$ such that $x \in X$ and $y \in Y$. It follows that $[x, \alpha^{-1}(y)] \in E(G)$. Since α^{-1} also reverses the bipartition, there exists $x' \in X$ such that $\alpha(x') = y$. Hence $[x, x'] \in E(G)$ which contradicts that X and Y are the partite sets of G .

We must show that the graph on the vertices of set X in G^α is connected as well as the graph on the vertices of set Y . From Proposition 2.14, we know that $G \times K_2 \cong G^\alpha \times K_2$. Since G is bipartite, we know that $G \times K_2 \cong 2G$ from Proposition 1.24. Because G is connected, $2G$ has two components. Hence, $G \times K_2$ has two components. It follows that $G^\alpha \times K_2$ has exactly two components. Therefore, the graph on the vertices of set X in G^α is connected as well as the graph on the vertices of set Y , for otherwise $G^\alpha \times K_2$ would have more than two components. \square

EXAMPLE 3.7. Going back to Example 3.3, recall that μ reverses the bipartition of G . Note that G^μ as pictured in Figure 3.4 has two components, one on the white vertices and one on the gray vertices.

LEMMA 3.8. Let $\gamma \in \text{Ant}(G)$ such that $\gamma^2 = \text{id}$ and γ reverses the bipartition. Then G^γ consists of exactly two components, each isomorphic to the other.

Proof. Let G be a bipartite graph with partite sets X and Y . Let $\gamma \in \text{Ant}(G)$ such that γ reverses the bipartition. From Lemma 3.6, we know that G^γ consists of exactly two components, a component on the vertices of X and a component on the vertices of Y . Call

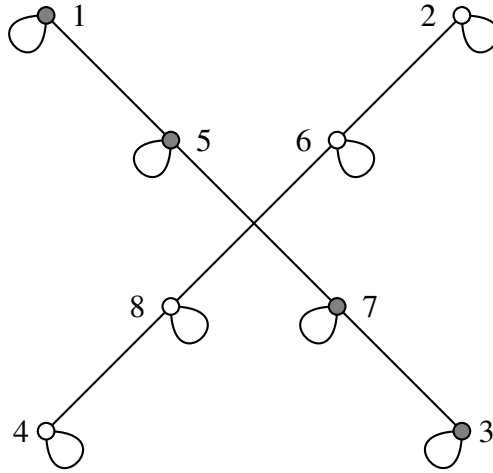
Figure 3.4: Example 3.7, Graph G^μ

these components G_X^γ and G_Y^γ respectively. Let $\theta : X \rightarrow Y$ such that $\theta(x) = \gamma(x)$. We will show that θ is an isomorphism $G_X^\gamma \rightarrow G_Y^\gamma$.

Clearly, θ is a bijection. It follows that

$$\begin{aligned}
 [x, x'] \in E(G_X^\gamma) &\Leftrightarrow [x, \gamma^{-1}(x')] \in E(G) && \text{for } x, x' \in X \\
 &\Leftrightarrow [x, \gamma(x')] \in E(G) && \gamma = \gamma^{-1} \\
 &\Leftrightarrow [\gamma(x), \gamma(\gamma(x'))] \in E(G) && \text{because } \gamma \in \text{Aut}(G) \\
 &\Leftrightarrow [\gamma(x), x'] \in E(G) && \gamma^2 = \text{id} \\
 &\Leftrightarrow [\gamma(x), \gamma(x')] \in E(G^\gamma) \\
 &\Leftrightarrow [\gamma(x), \gamma(x')] \in E(G_Y^\gamma) && \text{since } \gamma(x), \gamma(x') \in Y.
 \end{aligned}$$

Because $[x, x'] \in E(G_X^\gamma)$ if and only if $[\gamma(x), \gamma(x')] \in E(G_Y^\gamma)$ and θ is bijective, it follows that θ is an isomorphism. Thus, $G_X^\gamma \cong G_Y^\gamma$. \square

Note that in Example 3.7, the anti-automorphism μ obeys $\mu^2 = \text{id}$ and so the two components of G^μ are isomorphic.

3.2 Characterizing Solutions of $G \times B \cong X \times B$ for bipartite G

In addition to characterizing the solutions of $G \times B \cong X \times B$ for bipartite G , we will also characterize bipartite G for which G is a cancellation graph. This amounts to applying the characterization of the solutions of $G \times B \cong X \times B$ to the situation where there is only one solution.

THEOREM 3.9. Let G be a bipartite graph. Let $\alpha \in \text{Ant}(G)$. If α preserves the bipartition, then $G^\alpha \cong G$. Otherwise, there are involutions γ and σ of G which reverse the bipartition such that one component of G^α is a component of G^γ and the other component of G^α is a component of G^σ .

Proof. For α preserving the bipartition, we proved $G^\alpha \cong G$ in Proposition 3.4.

Let G be a bipartite graph with partite sets X and Y and let $\alpha \in \text{Ant}(G)$ such that α reverses the bipartition. We will define two functions σ and γ and show that they are both involutions such that one component of G^α is isomorphic to a component of G^σ and the other component of G^α is isomorphic to a component of G^γ . Let

$$\sigma = \begin{cases} \alpha(x) & \text{if } x \in X \\ \alpha^{-1}(y) & \text{if } y \in Y \end{cases}.$$

First, we will show that σ has order two. We do this by showing that $\sigma^2(x) = x$ for all $x \in X$ and $\sigma^2(y) = y$ for all $y \in Y$. Let $x \in X$.

$$\begin{aligned} \sigma^2(x) &= \sigma(\sigma(x)) \\ &= \sigma(\alpha(x)) && \text{by definition of } \sigma \\ &= \alpha^{-1}(\alpha(x)) && \text{since } \alpha(x) \in Y \\ &= x. \end{aligned}$$

Next observe that for $y \in Y$,

$$\begin{aligned}
 \sigma^2(y) &= \sigma(\sigma(y)) \\
 &= \sigma(\alpha^{-1}(y)) && \text{by definition of } \sigma \\
 &= \alpha(\alpha^{-1}(y)) && \text{since } \alpha^{-1}(y) \in X \\
 &= y.
 \end{aligned}$$

Therefore, $\sigma^2 = \text{id}$.

Next we will show that σ is an involution by showing that σ is an automorphism of G . First, Because G is bipartite, every edge in G must have one vertex x in X and one vertex y in Y . Then

$$\begin{aligned}
 [x, y] \in E(G) &\Leftrightarrow [\alpha(x), \alpha^{-1}(y)] \in E(G) && \text{by def of anti-automorphism} \\
 &\Leftrightarrow [\sigma(x), \sigma(y)] \in E(G)
 \end{aligned}$$

Therefore, $[x, y] \in E(G)$ if and only if $[\sigma(x), \sigma(y)] \in E(G)$. Thus $\sigma \in \text{Aut}(G)$. Because σ is an automorphism of order 2, it follows that σ is an involution.

Now we will define γ and show that γ is an involution. Let

$$\gamma = \begin{cases} \alpha(y) & \text{if } y \in Y \\ \alpha^{-1}(x) & \text{if } x \in X \end{cases}.$$

First, we will show that $\gamma^2 = \text{id}$. We do this by showing that $\gamma^2(x) = x$ for all $x \in X$ and

$\gamma^2(y) = y$ for all $y \in Y$. Let $x \in X$.

$$\begin{aligned}
 \gamma^2(x) &= \gamma(\gamma(x)) \\
 &= \gamma(\alpha^{-1}(x)) && \text{by definition of } \gamma \\
 &= \alpha(\alpha^{-1}(x)) && \text{since } \alpha^{-1}(x) \in Y \\
 &= x.
 \end{aligned}$$

For $y \in Y$,

$$\begin{aligned}
 \gamma^2(y) &= \gamma(\gamma(y)) \\
 &= \gamma(\alpha(y)) && \text{by definition of } \gamma \\
 &= \alpha^{-1}(\alpha(y)) && \text{since } \alpha(y) \in X \\
 &= y.
 \end{aligned}$$

Therefore, $\gamma^2 = \text{id}$.

Next we will show that γ is an involution by showing that γ is an automorphism of G . Because G is bipartite, every edge in G must have one vertex in X and one vertex in Y . Then

$$\begin{aligned}
 [x, y] \in E(G) &\Leftrightarrow [\alpha^{-1}(x), \alpha(y)] \in E(G) && \text{by def. of anti-automorphism} \\
 &\Leftrightarrow [\gamma(x), \gamma(y)] \in E(G)
 \end{aligned}$$

Therefore, $[x, y] \in E(G)$ if and only if $[\gamma(x), \gamma(y)] \in E(G)$ and so $\gamma \in \text{Aut}(G)$. Because γ is an automorphism of order 2, it follows that γ is an involution.

Now we will show that every edge in G^α joining the vertices of X is an edge of G^γ . So,

$$\begin{aligned}
[x, \alpha(y)] \in G^\alpha \text{ with } x, \alpha(y) \in X &\Leftrightarrow [x, y] \in E(G) \text{ such that } x \in X, y \in Y \\
&\Leftrightarrow [x, \gamma(y)] \in E(G^\gamma) \\
&\Leftrightarrow [x, \alpha(y)] \in E(G^\gamma) \text{ with } x, \alpha(y) \in X \quad \text{by def. of } \gamma.
\end{aligned}$$

Similarly, we will show that every edge in G^α joining the vertices of Y is an edge of G^σ .

We have

$$\begin{aligned}
[y, \alpha(x)] \in G^\alpha \text{ with } y, \alpha(x) \in Y &\Leftrightarrow [y, x] \in E(G) \text{ such that } x \in X, y \in Y \\
&\Leftrightarrow [y, \sigma(x)] \in E(G^\sigma) \\
&\Leftrightarrow [y, \alpha(x)] \in E(G^\sigma) \text{ with } y, \alpha(x) \in Y \quad \text{by def. of } \sigma.
\end{aligned}$$

Therefore, G^α contains one copy of a component of G^γ and one copy of a component of G^σ .

□

EXAMPLE 3.10. Recall graph G from Figure 3.3. We can see Theorem 3.9 manifested in the graphs G^α and $G^{\alpha^{-1}}$ by comparing these permuted graphs to G^μ and G^λ where μ and λ are involutions of G . Refer to Figure 3.5. Note that the component on the white vertices of G^α is isomorphic to a component of G^μ and the component on the gray vertices of G^α is isomorphic to a component of G^λ . Similarly, the component on the white vertices of $G^{\alpha^{-1}}$ is isomorphic to a component of G^λ and the component on the gray vertices of $G^{\alpha^{-1}}$ is isomorphic to a component of G^μ .

In order to characterize the solutions X of $G \times B \cong X \times B$, we would like to know if the converse of Theorem 3.9 is true. In other words, if given two involutions μ and λ , does there exist an anti-automorphism α such that one component of G^α is isomorphic to one

component of G^μ and the other component of G^α is isomorphic to one component of G^λ ?

COROLLARY 3.11. Let γ and σ be involutions of bipartite graph G which reverse the bipartition. Then there exists an anti-automorphism α such that one component of G^α is isomorphic to a component of G^γ and one component of G^α is isomorphic to a component of G^σ .

Proof. Let G be a bipartite graph with partite sets X and Y . Let

$$\alpha = \begin{cases} \sigma(x) & \text{if } x \in X \\ \gamma(y) & \text{if } y \in Y, \end{cases} \quad \text{so that} \quad \alpha^{-1} = \begin{cases} \gamma(x) & \text{if } x \in X \\ \sigma(y) & \text{if } y \in Y. \end{cases}$$

To check that α is an anti-automorphism, for $x \in X$ and $y \in Y$,

$$\begin{aligned} [x, y] \in E(G) &\Leftrightarrow [\sigma(x), \sigma(y)] \in E(G) && \sigma \text{ is an automorphism} \\ &\Leftrightarrow [\alpha(x), \alpha^{-1}(y)] \in E(G) && \text{def. of } \alpha \end{aligned}$$

and

$$\begin{aligned} [x, y] \in E(G) &\Leftrightarrow [\gamma(x), \gamma(y)] \in E(G) && \gamma \text{ is an automorphism} \\ &\Leftrightarrow [\alpha^{-1}(x), \alpha(y)] \in E(G). && \text{def. of } \alpha \end{aligned}$$

Therefore, $\alpha \in \text{Ant}(G)$.

Now we will check that G^α consists of one component from G^γ and one component from G^σ .

Suppose that $x, y \in X$. Then

$$\begin{aligned}
[x, y] \in G^\alpha &\Leftrightarrow [x, \alpha^{-1}(y)] \in G \\
&\Leftrightarrow [x, \gamma(\alpha^{-1}(y))] \in G^\gamma \\
&\Leftrightarrow [x, \alpha(\alpha^{-1}(y))] \in G^\gamma && \text{by def. of } \gamma \text{ and } \alpha^{-1}(y) \in Y \\
&\Leftrightarrow [x, y] \in G^\gamma
\end{aligned}$$

Therefore, the component of G^α on the vertices of X is isomorphic to a component of G^γ .

Similarly, suppose that $x, y \in Y$. Then

$$\begin{aligned}
[y, x] \in G^\alpha &\Leftrightarrow [y, \alpha^{-1}(x)] \in G \\
&\Leftrightarrow [y, \sigma(\alpha^{-1}(x))] \in G^\sigma \\
&\Leftrightarrow [y, \alpha(\alpha^{-1}(x))] \in G^\sigma && \text{by def. of } \sigma \text{ and } \alpha^{-1}(x) \in X \\
&\Leftrightarrow [y, x] \in G^\sigma
\end{aligned}$$

Therefore, the component of G^α on the vertices of Y is isomorphic to a component of G^σ . □

Thus for the bipartite case, we can reduce the problem of finding all the solutions X of $G \times B \cong X \times B$ to finding all $E(G!)$ -orbits of bipartite reversing involutions, which informs us of all $E(G!)$ -orbits of non-involution anti-automorphisms.

COROLLARY 3.12. Let G be a bipartite graph and n be the number of $E(G!)$ -orbits of the bipartition reversing involutions of G . Then $G \times B \cong X \times B$ has exactly $n + \binom{n}{2} + 1$ unique solutions.

Proof. First, we know that a solution of $G \times B \cong X \times B$ is $X = G$. Then, we will have n more unique solutions from the conjugacy classes of the involutions of G . From Corollary 3.11, each pair of involution conjugacy classes together forms a unique anti-automorphism equivalence class. \square

Going back to Example 3.3, G has two reversing involutions μ and λ . So there should be $1 + 2 + \binom{2}{2} = 4$ unique solutions to $G \times B \cong X \times B$ for any bipartite graph B . The reader can check using Table 3.1 that $\text{Ant}(G)$ has the following $E(G!)$ -orbits: $\{\text{id}, \alpha^2\}$, $\{\alpha, \alpha^{-1}\}$, $\{\mu\}$, and $\{\lambda\}$. Indeed, we have found the 4 solutions. See Figures 3.5 and 3.1.

Now that we have characterized all solutions of $G \times B \cong X \times B$ for bipartite G , we can characterize bipartite cancellation graphs as a direct corollary from the preceding results.

COROLLARY 3.13. A bipartite graph G is a cancellation graph if and only if G has no bipartition reversing involutions.

Figure 3.5: Example 3.10, Graphs G^μ , G^λ , G^α , $G^{\alpha^{-1}}$

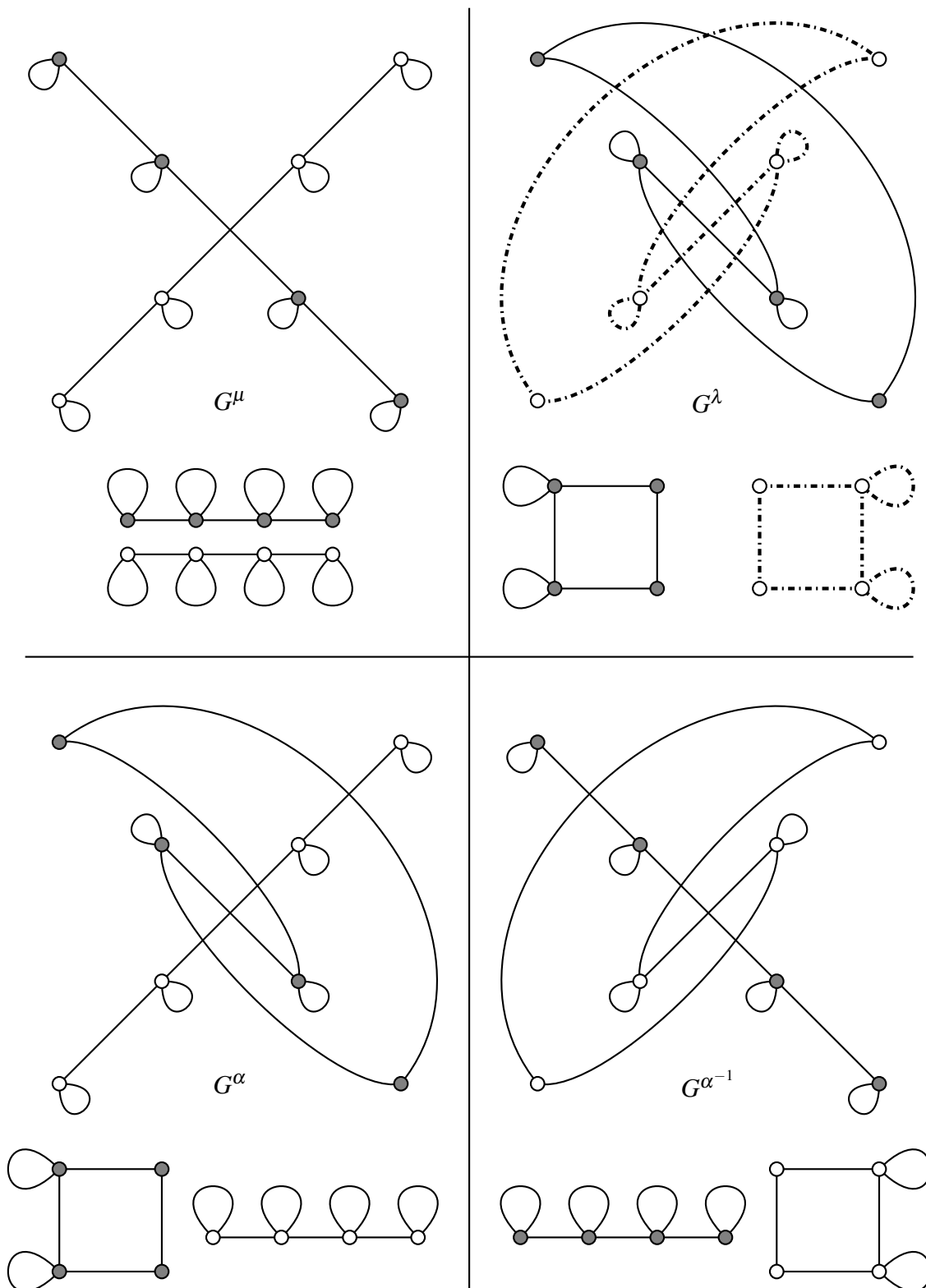

General Cancellation Graphs

Suppose that $G \times B \cong X \times B$ for bipartite B . Recall from the proof of Proposition 2.14 that using Lovász' results, we proved $G \times K_2 \cong X \times K_2$. Abay-Asmerom, Hammack, Larson, and Taylor [8] related the solutions X to the bipartite reversing involutions of bipartite connected graph $G \times K_2$. Though related, we would like to characterize solutions X of $G \times B \cong X \times B$ by the properties of G .

Although there remains some mystery surrounding the solutions of $G \times B \cong X \times B$ for non-bipartite G , in every example we have looked at, all automorphisms of G are in the same $E(G!)$ -orbit as an involution. In this chapter, we will first look at two standard non-bipartite graphs and find their $E(G!)$ -orbits. Then we will give an example of a non-bipartite cancellation graph and present some partial results.

4.1 Standard Non-Bipartite Graphs

EXAMPLE 4.1. We would like to find the solutions to $K_n \times B \cong X \times B$. Thus, we must find all the $E(K_n!)$ -orbits of anti-automorphisms.

We claim that every anti-automorphism of K_n has order 2.

Suppose to the contrary that there exists an anti-automorphism of K_n that has order greater than 2. Suppose that $(a b \cdots c)$ is a cycle in the cycle decomposition of an automorphism. Because K_n is complete, $[c, b] \in E(K_n)$. Therefore, we have the following edge of $E(K_n)$:

$$[(a b \cdots c)(c), (a b \cdots c)^{-1}(b)] = [(a b \cdots c)(c), (a c \cdots b)(b)] = [a, a].$$

However, K_n does not contain any loops.

Thus, all anti-automorphisms of K_n have order 2 or less. Hence, all anti-automorphisms are involutions or the identity. Because K_n is complete, then any permutation on n elements will be an automorphism of K_n . Hence, each permutation has a loop in $K_n!$. Because every automorphism of order 2 is an anti-automorphism, every order 2 permutation of the vertices of K_n is an anti-automorphism.

Now, we will look at the $E(K_n!)$ -orbits of the involutions. First, consider 2-cycles. Let $(a b)$ and $(c d)$ be two anti-automorphisms of K_n . Note that $(b d a c)$ is an automorphism of K_n and

$$[(b d a c), (b d a c)].(a b) = (b d a c)(a b)(b d a c)^{-1} = (b d a c)(a b)(b c a d) = (c d).$$

Therefore, each 2-cycle anti-automorphism of K_n is in the same $E(K_n!)$ -orbit as all other 2-cycle anti-automorphisms.

Likewise, each permutation consisting of j disjoint 2-cycles (in simplest form) is in the same $E(K_n!)$ -orbit as every other permutation consisting only of j disjoint 2-cycles.

Notice that every 2-cycle in a permutation β creates two loops in $(K_n)^\beta$. For $\beta = (a b)$, in $(K_n)^\beta$ only vertices a and b have a loop and are not adjacent in $(K_n)^\beta$. Besides these changes, $(K_n)^\beta$ is identical to K_n . For each $\alpha \in \text{Ant}(G)$, the graph $(K_n)^\alpha$ has i loops where $i \in \left\{0, 2, 4, 6, \dots, 2 \left\lfloor \frac{n}{2} \right\rfloor\right\}$. Thus there are $\left\lfloor \frac{n}{2} \right\rfloor + 1$ different solutions to $K_n \times B \cong X \times B$. See Figure 4.1 for examples of solutions.

EXAMPLE 4.2. Consider C_n for odd n . We would like to know all solutions X in the expression $C_n \times B \cong X \times B$. We also would like to find $C_n!$. We know that C_n has rotation and reflection symmetries as depicted in Figure 4.2. Let ω be the counterclockwise rotation of $\frac{360}{n}$ degrees. Notice that each reflection of C_n fixes exactly one vertex of C_n . Call the reflection that fixes vertex k reflection r_k .

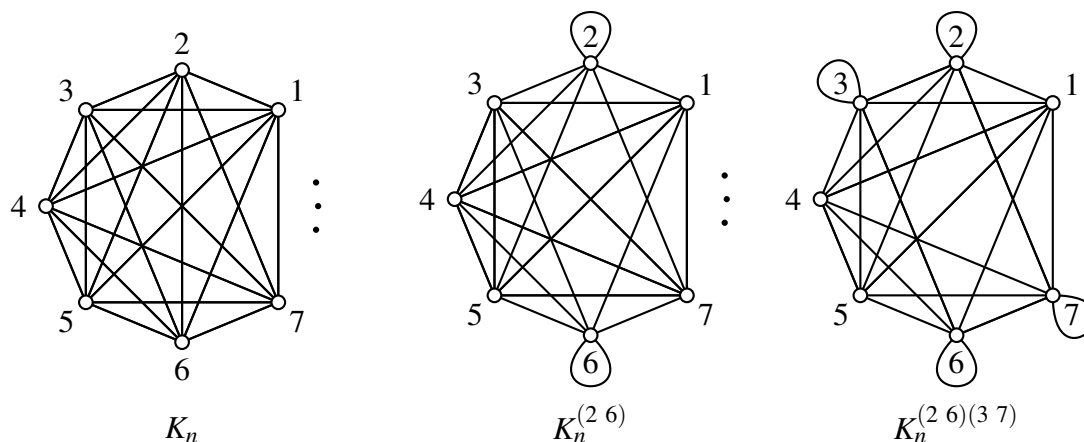

Figure 4.1: Some solutions to $K_n \times B \cong X \times B$ from Example 4.1

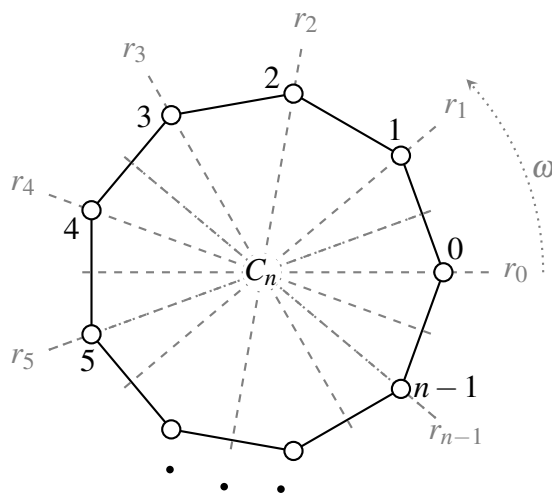

Figure 4.2: C_n

First, we will show that all anti-automorphisms have order two. Then we will confirm that both reflections and rotations are indeed automorphisms. Then, we will find the automorphisms that are anti-automorphisms. This will lead us to find all solutions $(C_n)^\alpha$ for $\alpha \in \text{Ant}(G)$.

PROPOSITION 4.3. For odd n , all the anti-automorphisms of C_n are the identity or involutions.

Proof. The proposition is trivial if C_n is a loop. Suppose that C_n is not a loop. Then by

definition of cycle, $n \geq 3$. Let us label the vertices of C_n as $0, 1, 2, \dots, n-1$. Let $\alpha \in \text{Ant}(G)$. We will show that $\alpha = \alpha^{-1}$.

Suppose $\alpha(0) = i$. Because $[\alpha(0), \alpha^{-1}(1)] \in E(C_n)$, either $[\alpha(0), \alpha^{-1}(1)] = [i, i+1]$ or $[\alpha(0), \alpha^{-1}(1)] = [i, i-1]$. Without loss of generality, suppose $[\alpha(0), \alpha^{-1}(1)] = [i, i+1]$. It follows that $[\alpha^{-1}(1), \alpha(2)] = [i+1, i+2]$. Continuing around the cycle, we see that $\alpha(n-1) = i+n-1 \pmod n$ since n is odd. Therefore,

$$[\alpha(n-1), \alpha^{-1}(0)] = [i+n-1 \pmod n, i+n-1+1 \pmod n]$$

. Therefore, $\alpha^{-1}(0) = i$. Persisting in the same way, $\alpha(j) = \alpha^{-1}(j)$ for all $0 \leq j \leq n-1$. Therefore, $\alpha^2 = \text{id}$ and so α is the identity or an involution. \square

PROPOSITION 4.4. For odd n , the only automorphisms of C_n are rotations and reflections.

Proof. First, note that if C_n is a loop, clearly the only automorphism is the identity. Suppose that C_n is not a loop. Then by definition of cycle, $n \geq 3$. Let us label the vertices of C_n as $0, 1, 2, \dots, n-1$. Suppose that β is an automorphism of C_n that maps 0 to i for $0 \leq i \leq n-1$. Then $[\beta(0), \beta(1)] \in E(G)$ which implies that $[\beta(0), \beta(1)] = [i, i+1 \pmod n]$ or $[i, i-1 \pmod n]$.

Case 1: Suppose that $[\beta(0), \beta(1)] = [i, i+1 \pmod n]$. Therefore, $\beta(1) = 1+i \pmod n$. Now, we consider edge $[1, 2]$. Because β is an automorphism and $[0, 1] \neq [1, 2]$, then $[\beta(0), \beta(1)] \neq [\beta(1), \beta(2)]$. Therefore, $[\beta(1), \beta(2)] = [i+1 \pmod n, i+2 \pmod n]$. Thus, $\beta(2) = i+2 \pmod n$. Repeating this process shows that $\beta(k) = k+i \pmod n$ for all $0 \leq k \leq n-1$. Thus, β is a counterclockwise rotation by $i \left(\frac{360}{n}\right)$ degrees for $0 \leq i \leq n-1$. Note that the identity is included in this case for $i = 0$.

Case 2: Suppose that $[\beta(0), \beta(1)] = [i, i-1 \pmod n]$. Therefore, $\beta(1) = 1-i \pmod n$. Now, consider edge $[1, 2]$. Because β is an automorphism and $[0, 1] \neq [1, 2]$, it follows

that $[\beta(0), \beta(1)] \neq [\beta(1), \beta(2)]$. Therefore, $[\beta(1), \beta(2)] = [i - 1 \pmod n, i - 2 \pmod n]$. So $\beta(2) = i - 2 \pmod n$. Repeating this process shows that $\beta(k) = i - k \pmod n$ for all $0 \leq k \leq n - 1$. Careful observation reveals that this is a line of reflection.

If i is odd and C_n is represented as in Figure 4.2, then β is the reflection fixing vertex $-\frac{n-i}{2} \pmod n$. If i is even then β is the reflection that fixes $\frac{i}{2}$.

□

Now we need to show that the rotation automorphisms are not anti-automorphisms.

PROPOSITION 4.5. For odd n , rotation automorphisms of C_n are not anti-automorphisms except the identity.

Proof. Let β be a non-identity rotation automorphism of C_n with labelings shown in 4.2. Then $\beta(k) = i + k \pmod n$ for $0 < k \leq n - 1$ and $0 \leq k \leq n - 1$. Suppose to the contrary that β is an anti-automorphism. Therefore, $[\beta(0), \beta^{-1}(1)] \in E(C_n)$. Thus either $[\beta(0), \beta^{-1}(1)] = [i, i + 1]$ or $[\beta(0), \beta^{-1}(1)] = [i, i - 1]$.

Case 1: Suppose that $[\beta(0), \beta^{-1}(1)] = [i, i + 1]$. Therefore, $\beta(i + 1) = 1$. By definition of β , this implies that

$$i + 1 + i \equiv 1 \pmod n$$

$$2i + 1 \equiv 1 \pmod n$$

therefore,

$$n | 2i + 1 - 1$$

and so

$$n | 2i.$$

Because n is odd, this implies that $n | i$. Therefore, $n < i$ which is a contradiction.

Case 2: Suppose that $[\beta(0), \beta^{-1}(1)] = [i, i-1]$. Therefore, $\beta(i-1) = 1$. By definition of β , this implies that

$$i-1+i \equiv 1 \pmod{n}$$

$$2i-1 \equiv 1 \pmod{n}$$

therefore,

$$n|2i-2$$

which implies

$$n|2(i-1).$$

Because n is odd, then $n|i-1$ which implies $n < i-1$. This contradicts that $i < n$.

Therefore, non-identity rotations of C_n are not anti-automorphisms. \square

These two propositions together imply that reflections are the only anti-automorphisms of C_n for odd n . Clearly, reflections have order two and so these reflections are involutions. Note that there are n different reflections for C_n . This gives us the structure for $C_n!$ which is depicted in Figure 4.3.

Because ω is an automorphism, then $[\omega, \omega]$ is an edge of the factorial $C_n!$. The reader can check that $[\omega, \omega].r_i = r_{i+1 \pmod{n}}$. Therefore, $r_i \simeq r_j$ for all pairs i and j such that $0 \leq i \leq n-1$ and $0 \leq j \leq n-1$. Therefore, there are only two $E(C_n!)$ -orbits of anti-automorphisms of C_n , the orbit containing all the reflections and the orbit containing the identity. Thus there are two solutions X for $C_n \times B \cong X \times B$ which are graphs C_n and $(C_n)^{r_i}$. The solution $(C_n)^{r_i}$ depicted in Figure 4.4.

Notice that for both K_n and C_n , all solutions to $K_n \times B \cong X \times B$ and $C_n \times B \cong X \times B$ are in the form G^β for β an involution. Recall that this is unlike the bipartite case where we had anti-automorphisms of order 4 that were not in the same $E(G!)$ -orbit as an involution.

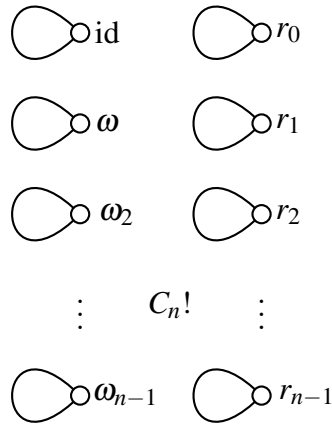
Figure 4.3: $C_n!$

4.2 Non-Bipartite Cancellation Graphs

Before giving partial results, let us look at an example of a non-bipartite cancellation graph.

EXAMPLE 4.6. Consider graph G from Figure 4.5. This is a cancellation graph for the following reasons. Let $\alpha \in \text{Ant}(G)$. Then $[\alpha, \alpha^{-1}]$ is an edge of $G!$. Note that $\deg(v_1) = 1$, $\deg(v_2) = 3$, $\deg(v_3) = 2$ and $\deg(v_4) = 3$. From Proposition 2.23, we know that α and α^{-1} must act as the identity on v_1 and v_3 and can only permute v_2 and v_4 among themselves. Suppose α maps v_2 to v_4 . But $[\alpha(v_1), \alpha^{-1}(v_2)] = [v_1, v_4]$ which is not an edge of G . Therefore, any anti-automorphism must be the identity. Hence, G is a cancellation graph.

PROPOSITION 4.7. If G has no involutions then G is a cancellation graph.

Proof. We will prove this contrapositively. Suppose that G is not a cancellation graph. Then there exists some $\alpha \in \text{Ant}(G)$ such that $G^\alpha \not\cong G$. Thus, α is not in the same $E(G!)$ -orbit as id . We will show that the existence of α requires G to have an involution. Let n be the order of α . Hence $\alpha^n = \text{id}$. There are two cases: either n is a multiple of four or n is not a multiple of four.

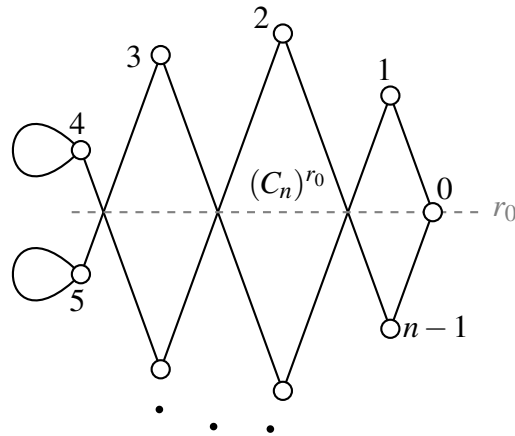
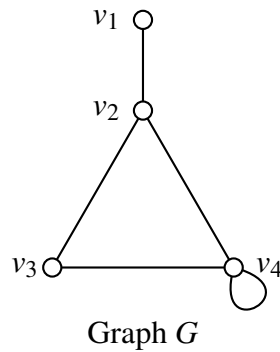
Figure 4.4: $(C_n)^{r_0}$ Figure 4.5: Graph G , Example 4.6

Case 1: Suppose that $n \not\equiv 0 \pmod{4}$. Then by Proposition 2.26, α is in the same $E(G!)$ -orbit as an involution β of G . Therefore, G has an involution β .

Case 2: Suppose that $n \equiv 0 \pmod{4}$. Note that n is divisible by two. Because α is an anti-automorphism, then $[\alpha, \alpha^{-1}] \in E(G!)$. That $E(G!)$ is closed under multiplication implies that

$$\underbrace{[\alpha, \alpha^{-1}][\alpha, \alpha^{-1}] \cdots [\alpha, \alpha^{-1}]}_{\frac{n}{2} \text{ factors}} = [\alpha^{\frac{n}{2}}, (\alpha^{-1})^{\frac{n}{2}}] = [\alpha^{\frac{n}{2}}, \alpha^{\frac{n}{2}}] \in E(G!).$$

It follows that $[x, y] \in E(G)$ if and only if $[\alpha^{\frac{n}{2}}(x), \alpha^{\frac{n}{2}}(y)] \in E(G)$. Therefore, $\alpha^{\frac{n}{2}}$ is an automorphism of G . Furthermore, $(\alpha^{\frac{n}{2}})^2 = \alpha^n = \text{id}$. Thus, $\alpha^{\frac{n}{2}}$ is an automorphism of order

two and is thus an involution of G . □

Notice that the converse of this is false. There exist bipartite graphs with only bipartite-preserving involutions and these graphs are cancellation graphs. Recall that Proposition 3.4 implies that such an involution is in the same $E(G!)$ -orbit as the identity.

EXAMPLE 4.8. Consider P_2 , the path of length 2 depicted in Figure 4.6. This is a bipartite graph such that the endpoints of the path are in one partite set and the middle vertex is in the other partite set. The only involution of P_2 is $(1\ 3)$. Note that $[(1\ 3), \text{id}] \in E(P_2!)$. Thus $[(1\ 3), \text{id}].(1\ 3) = (1\ 3)(1\ 3) = \text{id}$ shows that $(1\ 3)$ is in the same $E(P_2!)$ -orbit as the identity. So, $G^{(1\ 3)} \cong G$. It follows that G is a cancellation graph even though G has an involution.

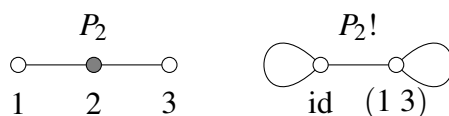

Figure 4.6: Graphs P_2 and $P_2!$, Example 4.8

The following conjecture is consistent with our characterization of bipartite cancellation graphs. We have yet to find an example of a non-bipartite graph with an anti-automorphism which is not in the same $E(G!)$ -orbit as an involution. If this is true for all non-bipartite graphs, then the conjecture will hold.

CONJECTURE 4.9. A graph G is a cancellation graph if and only if every involution of G is in the same $E(G!)$ -orbit as the identity.

Our goal is to find a stronger characterization of non-bipartite graphs than the above conjecture. The property that every involution of G is in the same $E(G!)$ -orbit as the identity is a fuzzy concept and is not rooted in the same simplicity as our characterization of bipartite cancellation graphs. We are hoping to find a similar simple structural characterization for the non-bipartite cancellation graph.

Bibliography

Bibliography

- [1] G. Chartrand, L. Lexniak, P. Zhang, *Graphs & Digraphs, 5th edition*, CRC Press, Taylor and Francis, Boca Raton, FL, 2011.
- [2] P.M. Weichsel, The Kronecker product of graphs. *Proceedings of the American Mathematical Society*, 13 (1962) 47-52.
- [3] L. Lovász, On the cancellation law among finite relational structures. *Periodica Math. Hungar.*, 1 (1971) 145-156.
- [4] R. Hammack, Cancellation of digraphs over the direct product. *European Journal of Combinatorics* 34 (2013) 846-858.
- [5] R. Hammack, On direct product cancellation of graphs. *Discrete Mathematics* 309 (2009) 2538-2543.
- [6] R. Hammack, K. Toman, Cancellation of direct products of digraphs, *Discusiones Mathematicae Graph Theory* 30(4) (2010) 575-590.
- [7] P. Hell and J. Nešetřil, *Graphs and Homomorphisms*, volume 28 of *Oxford Lecture Series in Mathematics and its Applications*. Oxford University Press, Oxford, 2004.
- [8] G. Abay-Asmerom, R. Hammack, C. Larson, D. Taylor, Direct Product factorization of bipartite graphs with bipartite-reversing involutions. *SIAM Journal on Discrete Mathematics*, 23(4)(2010) 2042-2052.

Vita

Cristina Mullican graduated from Cedarville University in 2010 with a B.S. in Mathematics. After teaching high school mathematics for two years, she enrolled in VCU's Masters in Mathematics program. She plans to earn her Ph.D. in Mathematics and become a professor.

When not doing mathematics, she enjoys spending time with her husband, eating good food, and making music.